

March 2013

B 25361

# CAN Newsletter

*Hardware + Software + Tools + Engineering*



*Update information on  
CAN with flexible data-rate (CAN FD)*

*Safe-guarding CAN FD for  
applications in trucks*

*Higher flexibility in automotive  
networks through CAN FD*

*Automotive electronics*

[www.can-newsletter.org](http://www.can-newsletter.org)

# A Perfect Fit For Your Embedded Design...



## The most popular choice of embedded designers.

Anzeige Microchip

Choosing an embedded semiconductor is much more than just picking a product. Over 70,000 companies, from the largest global enterprises to innovative start-ups, choose Microchip because:

### Microchip Understands Commercial Pressures

We have some of the best stock availability, the shortest leadtimes, an extensive range of channel partners and sell direct to any customer through our website.

### Microchip Offers Solutions for Today's Most Challenging Applications

Our product range encompasses an industry leading portfolio of 8-, 16-, and 32-bit microcontrollers, analog, memory, power management and wireless, as well as microcontrollers to meet the demands of applications, from touch sensing and driving displays to industrial control.

### Microchip Makes It Easy for Your Development Teams to Succeed

With hundreds of software tools and development boards, 35 regional training centres across the world and technical support available 24 hours a day, we help customers overcome challenges and bring products to market.

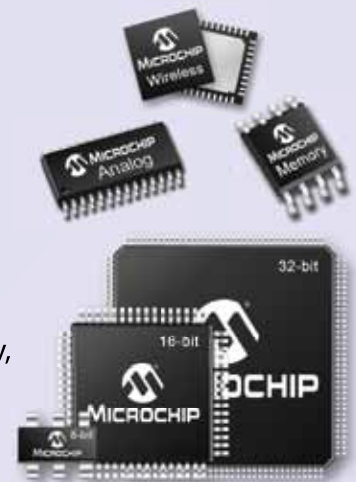

For more information, go to: [www.microchip.com](http://www.microchip.com)



Microcontrollers • Digital Signal Controllers • Analog • Memory • Wireless

# First-hand information on CAN FD



Full-house in Detroit: More than 100 participants listened to Marc Schreiner from Daimler's Research and Development department explaining CAN bandwidth requirements in trucks

Officially introduced on the international CAN Conference (iCC) in March 2012, the CAN FD protocol has been implemented by Bosch in an FPGA. During the CAN FD Tech Day in Detroit (October 2012) several chipmakers presented their roadmaps for CAN FD prod-

ucts. This year, CiA will organize a similar event in Europe. On March 19, the second CAN FD Tech Day will be held in Frankfurt (Germany). The speakers will update their presentations given in Detroit. In addition, Bosch, Daimler, and NXP will make available their

jointly developed CAN FD bridge module. It comprises two CAN FD ports and a classic CAN interface. This module is intended for evaluation purposes. It comprises one V850 micro-controller with on-chip CAN module by Renesas and two Altera FPGAs implementing

## Links

[www.bosch.com](http://www.bosch.com)  
[www.can-cia.org](http://www.can-cia.org)  
[www.nxp.com](http://www.nxp.com)

## CAN FD protocol

The CAN FD protocol is backwards compatible to the CAN protocol internationally standardized in ISO 11889-1. The improved protocol uses a second higher bit-rate starting in the control field and ending before the Acknowledgement field. The improved message format allows also longer data fields up to 64 byte. The CAN FD enhancements have been submitted to the International Standardization Organization (ISO).

## Related articles

F. Hartwich: *CAN with flexible data-rate*; in CAN Newsletter, June 2012

## Editor's comment

"This issue of the CAN Newsletter contains some detailed articles about CAN FD implementations and technology information. Most of the articles are based on the presentations given at the CAN FD Tech Day in Detroit. In the CiA, three Task Forces have started to publish recommendations and application hints. Perhaps, we can report in the June issue about the first work results." Holger Zeltwanger

## Statement on CAN FD from a semiconductor manufacturer

Wolfgang Wiewesiek, Manager Automotive Networks at Fujitsu Semiconductor Europe stated: "Fujitsu is selling large quantities of CAN nodes every year and monitors the trend of demand for higher bandwidth in the automotive network domain as well as in industrial applications closely. Fujitsu therefore welcomes the latest CAN protocol enhancement 'CAN with flexible data rate' as an excellent choice for the future, prolonging the lifetime of this successful network technology. Fujitsu will

integrate the M\_CAN IP from Bosch in its new micro-controller designs for automotive applications. In addition, products using the legacy CAN IP will – in case of new designs – be prepared for CAN FD tolerance, allowing a smooth migration option for existing network architectures.

FPGA-based CAN FD solutions for key automotive customers are in development and the first micro-controllers with embedded CAN FD protocol support will soon become available."

## CiA establishes Task Forces dealing with CAN FD networking

The CAN in Automation (CiA) international users' and manufacturers' group is calling for CAN FD experts interested in developing recommendations and best practice solutions for the improved CAN protocol. The Task Force "System design" will focus on finding applicable migration paths from today's "classic" CAN networks to CAN FD based networks. In addition, this Task Force may evaluate all new protocol features. The assigned tasks include solutions for mixing improved CAN and classic CAN nodes in one network. The Task Force "User interface and device design" should harmonize supported functionalities for CAN FD capable CAN controllers as well as the CAN module's CPU interface. In addition, this group may discuss the handling of the CAN controllers memory resources with regard to long data frames. The Task Force "Physical layer design" is going to develop recommendations for topology, bit-timing, etc. All Task Forces report to the CiA Interest Group "CAN FD".

the CAN FD protocol. "We expect that the chipmakers will provide in Frankfurt more detailed information on their CAN FD products," said Gisela Scheib from CiA organizing the upcoming CAN FD Tech Day. "First CAN FD prototype implementations will be shown some weeks before on the Embedded World trade show in Nuremberg." CiA plans to exhibit a running CAN FD demonstrator system on its booth.

Infineon will provide the improved CAN protocol with flexible data-rates in its micro-controllers. The chipmaker intends to support bit-rates of up to 8 Mbit/s using linear bus topologies. The IFX transceiver chip series is already specified for transmission speeds up to 2 Mbit/s. Faster one will be developed. NXP has announced the SJA1145 SPI-to-CAN FD chip, bridging micro-controllers to the improved CAN network. The stand-alone bus-controller will be available in samples end of this year. Besides the CAN FD controller, it also comprises a CAN transceiver with partial networking function compliant to ISO 11898-6, which is validated for data-rates up to 2 Mbit/s.

The CAN FD implementation will support data-fields up to 64 byte.

In Detroit, Kvaser showed on site its CAN FD implementation, a non-commercial FPGA solution. Ad hoc, it was connected to the CAN FD demonstrator built by Bosch and the tool partners Etas and Vector. And it was working in the demonstrator. You saw that it was acknowledging the CAN FD frames and switched correctly to the higher bit-rate and vice versa.

General Motors and Daimler's truck division explained in Detroit their requirements for higher performing CAN networks. They want to keep the robustness (physical layer) and the reliability (in particular, the Hamming distance of six provided by the classic CAN protocol) of the proven CAN communication. Daimler's engineers already spent some effort in the research of the CAN FD communication quality. They simulated the signal integrity in FD networks for bit-rate up to 2 Mbit/s. In a first estimation, the average bit-rate will approximately be doubled by an arbitration speed of 500 kbit/s and 2,5 Mbit/s for the data phase

using only 8-byte data frames and 29-bit CAN-IDs (extended frame format). In truck applications the gain of average bit-rate is limited by used extended frame format, and arbitration speed of 800 kbit/s due to topological constraints.

General Motors is interested in CAN FD for the end-of-line programming of ECUs. The increasing size of programs requires more and more time. And time is money. Reducing the production time, meaning the time to download software, saves a lot of money. The US carmaker will use in second step CAN FD also for the normal operation in the in-vehicle networks. There is some rumor that the other two big US carmakers – Chrysler and Ford – are interested in CAN FD, but there is no official statement available. Volkswagen is according to Carsten Schanze in the evaluation process and has not taken any decision regarding CAN FD. Guenther Linn said that Audi is also evaluating the new protocol, especially the compatibility to the selective wake-up transceivers as standardized in ISO 11898-6. According to Tim Robertson from Nissan, the Japanese carmaker is also studying the improved CAN protocol. Thomas Lindner from BMW stated that the Bavarian company has not yet started to look in detail to CAN FD. Other carmakers are not willing or able to make commitments on CAN FD. Some automobile suppliers are ready to migrate to CAN FD communication, but also they have not made an official commitment. Except Bosch, the inventor of the CAN improvements will support CAN FD in all of its powertrain ECUs.

No communication protocol without tools. From the beginning, the toolmakers were involved in the pre-development of the CAN FD protocol. Etas and Vector made already their CAN tools ready to support

CAN FD. Both companies presented prototypes in Detroit connected to the CAN FD demonstrator. The software suppliers for non-automotive applications, especially the CANopen protocol stack providers are waiting for the first CAN FD micro-controllers. In some CAN FD information events organized and co-organized by CiA, several CiA members (e.g. Etas, Ixxat, Port, Vector) presented the possibilities of CANopen applications using the improved CAN protocol. "Besides the European CAN FD Tech Day, CiA will schedule additional information events on request of interested parties in other countries," said Gisela Scheib.

*Holger Zeltwanger*



# You CAN get it...

Hardware & software for CAN bus applications...



LINUX device driver available



### PCAN-PCI/104-Express

CAN interface for PCI/104-Express systems. Available as 1-channel, 2-channel, and opto-isolated version.



### PCAN-PC/104-Plus Quad

Four-channel CAN interface with galvanic isolation for PC/104-Plus systems.



CAN bus diagnostics with trace function

### PCAN-Diag 2

PCAN-Diag 2 is a handheld CAN bus diagnostics unit. The new model offers enhanced functionality:

- \_\_\_ Clear CAN traffic representation in lists, configurable symbolic representation of received messages
- \_\_\_ Transmission of individual CAN frames or CAN frame lists
- \_\_\_ Built-in 2-channel oscilloscope for detailed analysis of the differential CAN signal or an optional external signal, triggering by CAN IDs or other events
- \_\_\_ Bit rate detection, bus load and termination measurement
- \_\_\_ Windows® software for easy device configuration and transmit list definition, upload via USB connection
- \_\_\_ Storage of diagnostic results (CSV, BMP) on an internal 1 GB mass storage USB device



### PCAN-PCI Express

CAN interface for PCI Express slots. 1, 2, and 4-channel versions with galvanic isolation available.



### PCAN-Repeater

Repeater for the galvanic isolation of 2 CAN bus segments, bus status display, switchable termination.

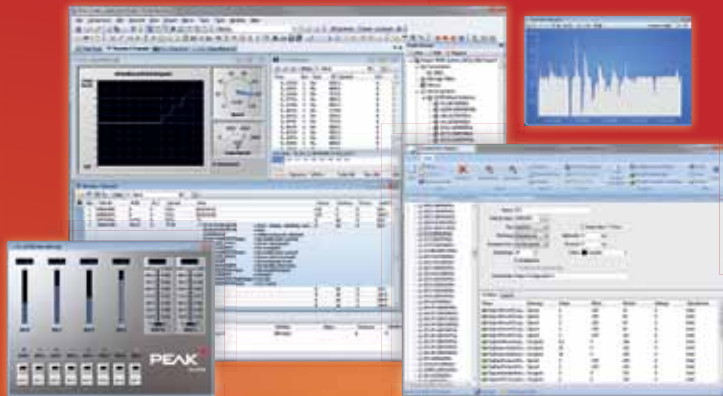

### PCAN-Explorer 5

The universal tool for developing and monitoring CAN networks.

- \_\_\_ Extensive user interface improvements: File management via projects, configuration of all elements with the property editor, and window arrangement using tabs
- \_\_\_ Simultaneous connections with multiple networks / CAN interfaces of the same hardware type
- \_\_\_ Configurable symbolic message representation
- \_\_\_ Data logging with tracers and the 4-channel Line Writer
- \_\_\_ VBScript interface for the creation of macros
- \_\_\_ Functionality upgrades with add-ins (e.g. **Plotter**, **J1939**, **CANdb Import**, or **Instruments Panel** add-in)
- \_\_\_ User interface language in English or German



### PCAN-miniPCIe

CAN interface for PCI Express Mini slots. Single- or dual-channel versions with isolation available.



### PCAN-USB Pro

High-speed USB 2.0 interface with galvanic isolation for connecting up to 2 CAN and 2 LIN busses.



### PCAN-Router

Programmable CAN router with 2 CAN channels. Available with D-Sub or Phoenix connectors.

New products at the embedded world 2013



You can find CAN to LAN or WLAN modules, the PEAK-gridARM evaluation board for the gridARM microcontroller, and the PCAN-Router in a DIN rail housing at PEAK-System in hall 1, booth 616.

[www.peak-system.com](http://www.peak-system.com)

Otto-Roehm-Str. 69, 64293 Darmstadt, Germany  
Phone: + 49 6151 8173-20 – Fax: + 49 6151 8173-29 – E-mail: [info@peak-system.com](mailto:info@peak-system.com)

**PEAK**  
System



## Cover story

First-hand information on CAN FD

3

This issue contains some detailed articles about CAN FD implementations and technology information. Most of them are based on the presentations given at the CAN FD Tech Day in Detroit (October 2012). During the event, several companies presented their roadmaps for CAN FD products.

## Imprint

### Publisher

CAN in Automation GmbH  
Kontumazgarten 3  
DE-90429 Nuremberg

publications@can-cia.org  
www.can-cia.org  
www.can-newsletter.org

Tel.: +49-911-928819-0  
Fax: +49-911-928819-79

CEO Holger Zeltwanger  
AG Nürnberg 24338

Printed in Germany  
Hard copies: 3500  
Soft copies: 2500

### Editors

(pr@can-cia.org)

Priyadarshini Bharathkumar  
Olga Fischer  
Cindy Weißmüller  
Holger Zeltwanger  
(responsible according  
to the press law)

### Layout

Bettina Seuffert-Bischoff

### Advertising manager

Gisela Scheib  
(responsible according  
to the press law)

### Distribution manager

Julia Adolf

### © Copyright

CAN in Automation GmbH



## Improved CAN

CAN – From its early days to CAN FD	8
Safe-guarding CAN FD for applications in trucks	12
Inventor presented the improved CAN data link layer	20
Higher flexibility in automotive networks through CAN FD	24
Automotive and industrial use cases for CAN FD	28



## Application

Control panel solution for printing machines	36
CAN data transmission via a radio link	44
CAN-based distributed control of a breakstone cleaner	46
Solar vehicle uses CAN for internal communication	50



## CANopen

CANopen Safety with Codesys Safety for SIL 2	38
Experimental CANopen EEC management	40
PLC controls CANopen drives via gateway	54

### HMS has acquired Ixxat

Just after the 25<sup>th</sup> anniversary of Ixxat (originally established as STZP technology transfer center), HMS has acquired the German company. The Swedish company is specialized in network and bus interface modules with some historical focus on Profibus and Profinet. Of course, the company offers since many years also conformance-tested DeviceNet and CANopen interface products. Ixxat has its routes in the CAN business, especially in PC-to-CAN interface units as well as in CAN-related protocol stacks and CAN tools. Both companies are CiA members. Ixxat participated and participates in many CiA internal groups. The companies expect some synergy effects, when combining their activities. In particular, the HMS' worldwide sales channels could increase Ixxat's business outside of Europe. On the other hand, HMS has access to the CAN and CANopen markets besides the already addressed industrial automation business. Together both companies will have 350 employees and a turnover of more than 50 million €.

More information you find on [www.can-newsletter.org](http://www.can-newsletter.org)



# The WAGO I/O CANopen<sup>®</sup> Product Range Keeps On Growing!

AUTOMATION



## NEW! IP67 Protected CANopen<sup>®</sup> Coupler

- Eight integrated digital inputs
- Extendable via system bus
- Maximum extension of 500 meters
- Expansion with up to 64 I/O modules
- High-performance, configurable I/O modules
- High diagnostic coverage
- Temperature range from -25 °C to +60 °C
- DS 301 communication profile
- DS 402 I/O profile
- Also available as 767-2501 Programmable Coupler



750-337



750-338



750-347



750-348



767-1501  
767-2501



750-837

WAGO Kontakttechnik GmbH & Co. KG  
Phone: +49/571/887-0  
Fax: +49/571/887-169  
[www.wago.com](http://www.wago.com)

**WAGO**<sup>®</sup>  
INNOVATIVE CONNECTIONS

# CAN – From its early days to CAN FD

Dr. Wilrid Dubitzky, Turgut Karacay

## Authors



Dr. Wilrid Dubitzky



Turgut Karacay

Etas GmbH  
Borsigstr. 14  
DE-70469 Stuttgart  
Tel.: +49-711-89661-0  
Fax: +49-711-89661-108

Link  
[www.etas.com](http://www.etas.com)

In the early days, automobiles were driven by pure horsepower. Optimizations by an intelligent information flow, e.g. to achieve an efficient combustion process, were not in focus. The exchange of information between different control systems and their sensors and actuators were realized by discrete interconnection, i.e. point-to-point wiring [1]. High currents were passed between ECUs (electronic control units) and the transferred information was comprised of 1-bit signals (on/off) rather than dates.

Later, more and more electronic devices were implemented into modern vehicles in order to increase safety and comfort for the driver as well as to reduce fuel consumption and exhaust emissions. The electronic devices included engine management systems, active suspension, anti-lock braking, gear control, lighting control, air conditioning, airbags and central locking. The requirement for information exchange has then grown to such an

extent that a cable network with a length of up to several miles and many connectors was required. This led to growing problems concerning material cost, production time and communication reliability. The revolutionary solution was the connection of the control systems via a serial bus system, the CAN network [1] invented by Robert Bosch in 1983. With CAN, point-to-point wiring was replaced by one serial bus connecting all control systems. This was accomplished by adding CAN-specific hardware to each control unit that provides the "rules" or the protocol for transmitting and receiving information via the network.

The first vehicle using a CAN bus in series production was the Daimler S-Class W140 in 1991 [1]. In this first step towards interconnection of electronic components via CAN, five CAN nodes were used to connect the engine control unit, the anti-lock braking and traction control system, the igni-

tion, the transmission control unit, and a diagnostic module. This interconnection allowed realizing different functions with the aim to reduce emissions and fuel consumption, improve driving behavior during warm-up, and optimize driving operation by interaction with the transmission control. For example, the slipping of a drive wheel could be reduced by intervention in ignition, fuel injection, and engine control.

## CAN as enabler for electronic architecture evolution

The complexity of automotive software has increased over time. This statement is underlined by different parameters shown in Figure 4 [2]. The number of systems in the vehicle that communicate with each other via a bus has increased over time. Between the years 1990 to 2000, the number of bus nodes grew from less than ten to greater than 40 systems. The addition and/or realization of

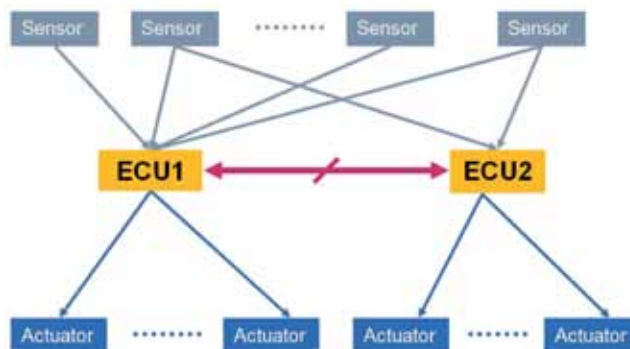
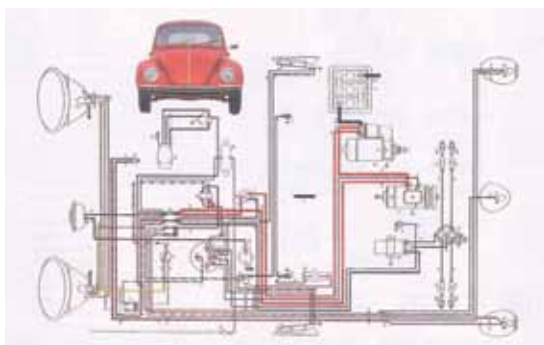

Figure 1: The wiring topology of a Volkswagen Beetle (left) had discrete connections between controls and sensors, and control and actuators (right). The information content passed to an actuator comprised 1 bit, switching the actuator states on or off.



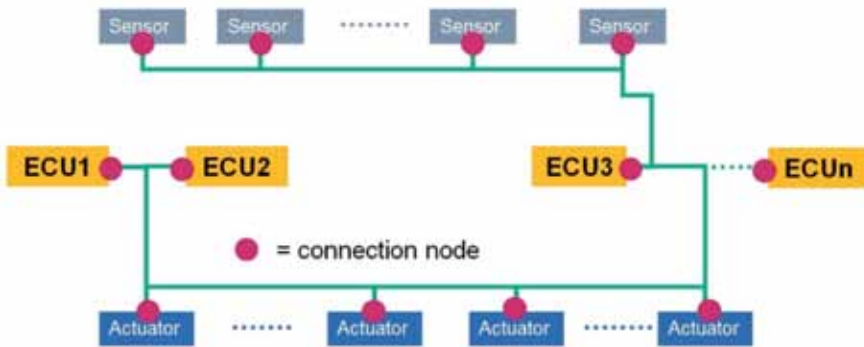

Figure 2: Modern topologies (on top) connect control systems, sensors, and actuators by a serial bus (bottom).

more complex functions in the engine control unit require more computing power. Approximately every ten years, the computing power of micro-controllers in automotive technology increased tenfold. This is related to Moore's Law, i.e. the doubling of the integration density on the semi-

conductor every 18 months. The lines of code for high-end cars and the memory requirements increased by two orders of magnitude over a time frame of ten years. Along with the growing number of connections, the number of exchanged signals grew by four orders of magnitude.

The electronic architecture of today's vehicles consists of more than 70 ECUs, which communicate via the CAN network. CAN played a significant role in the electrification of the system components. It facilitated the division of the electronic systems into manageable sub-systems,

thus increasing development efficiency.

The evolutionary development of the vehicle architecture has shown that the complexity grows quicker than the number of functions [2]. This leads to a problem in that the integration of new functions is getting more expensive and therefore weakens the innovation trend. Only through a significant revision of the vehicle's electronic architecture and a leap in network technology can reduce the complexity to a manageable level. In the past, the means to decrease complexity had been the introduction of CAN.

### Quo vadis CAN

The increasing complexity of functions leads to higher data-rates, thus bringing CAN to its limit (1 Mbit/s). Time-triggered communication technologies, such as those used with Flexray (10 Mbit/s), are complex in handling and require careful planning of the network. CAN FD (CAN with flexible data rate) provides an intermediate step between both. It provides a flexible but highly topology-dependent data-rate of up to 8 Mbit/s. ▶

Daimler S class W140 (1991)



Source: Daimler AG

Transmission Control and Ignition



Engine Control (fuel injection)



ABS/ASR



### References

- [1] Dr. S. Dais, CAN – Die Innovation im Automobil, Eduard-Rhein-Technologiepreis, 2008
- [2] Bundesministerium für Wirtschaft und Technik, Ecar-IKT-Systemarchitektur für Elektromobilität, 2011
- [3] T. Hogenmüller, M. Schaffert, B. Triess, Data Engine für schnelle Ethernet Architekturen, Hanser Automotive Edition 12, 2012

Figure 3: The Daimler S-Class W140 was the first vehicle using CAN with five connected nodes

## Facts explaining the success of the CAN technology

Although developed for vehicle technology, CAN has been adopted in many other industries with various technical applications. CAN chips are found in elevator systems of large buildings, ships, trains, aircrafts, X-ray machines and other medical equipment, logging equipment, tractors and combines, coffee makers, and other major appliances. In the automotive industry, CAN has become the industry standard for communication systems in vehicles, where today every new car built has at least one CAN system on board. Following facts mainly drove the success of the CAN technology:

- ◆ CAN was the first “real” protocol bus in the vehicle allowing the

implementation of more complex functionality while reducing the need for wiring in the vehicle.

- ◆ The open license policy of Bosch facilitated the availability of CAN on chip by micro-controller vendors in a very short time frame.
- ◆ CAN required small silicon area and low computing power. The low-cost CAN is available even on simple micro-controllers.
- ◆ The planning of time-triggered protocols such as Flexray, i.e. protocols, which assign each bus participant fixed time slots for communication is complex and inflexible. Even though the real-time behavior of a time-triggered protocol is predictable, the low planning effort of a CAN network

is one of its key success factors. Its flexibility allows for adding unplanned CAN nodes to the network at any time.

- ◆ CAN resolves network collision via a bitwise arbitration (CR: collision resolution). This means that the message with higher priority is sent. Contrary to this, Ethernet detects the collision but does not resolve it. With Ethernet, the message transmission is stopped. Both senders wait a random amount of time and then begin sending the message again. Collision resolution is the preferable method in a real-time communication network as messages with high priority have precedence.

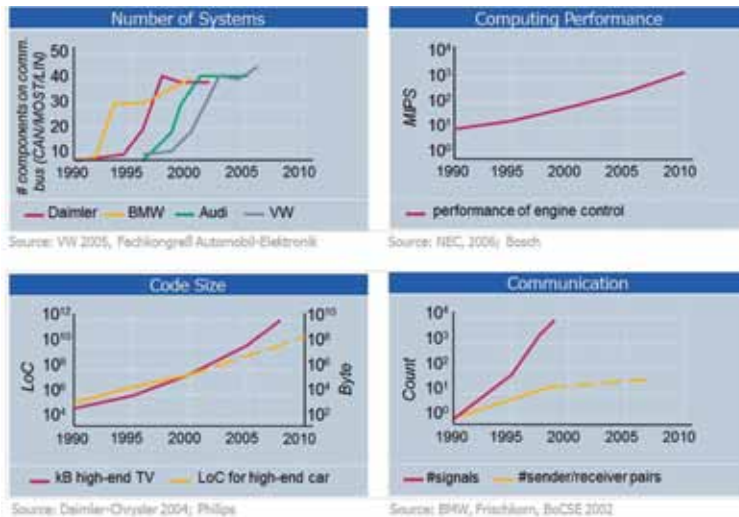

Figure 4: Increased functional complexity in the automotive industry over time. Top left: Number of components communicating on a bus. Top right: The computing performance of engine controls in million instructions per second (MIPS). Bottom left: The number of lines of code and the memory requirements. Bottom right: The number of exchanged signals.

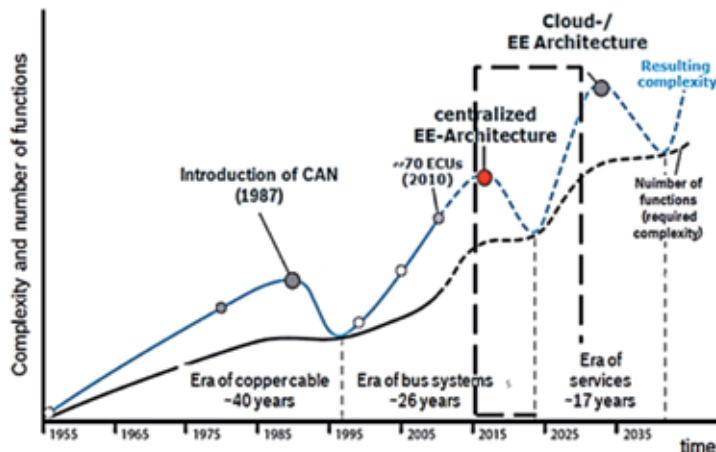

Figure 5: The complexity grows quicker than the number of functions. In the past, a turning point in complexity was the introduction of CAN. Today's turning point will be a different approach in organizing the vehicle's electronic architecture.

It is backward compatible with classic CAN and the migration effort is low:

- ◆ CAN wiring harnesses are available in the vehicle.
- ◆ CAN and CAN FD nodes can be mixed within a network.
- ◆ CAN FD needs low power consumption.

CAN FD meets future bandwidth requirements and builds a bridge towards Ethernet. One question arising in this context is whether CAN FD can co-exist with future network technologies such as Ethernet. Both technologies might co-exist in parallel for a long time, especially when taking into account the cost advantages and low migration effort. One possible future electronic architecture could be CAN FD sub-nets in the body and powertrain domain, which are integrated into an Ethernet backbone architecture, with local gateways for the protocol conversion (see Figure 6). With such architecture the success of CAN will continue with CAN FD.

The introduction of high-speed communication networks leads to additional challenges. High bandwidth requires high computing power, thus increasing

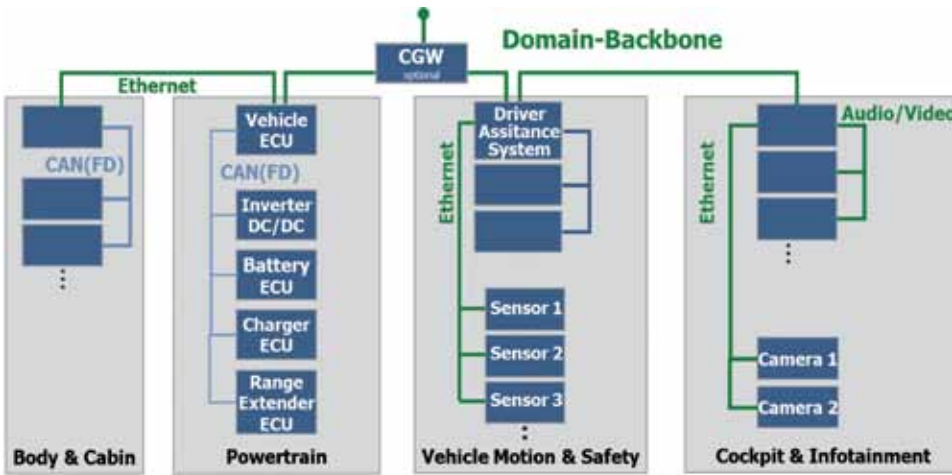

Figure 6: A modern centralized electronic architecture organized in domains. Automotive Ethernet is a candidate for inter-domain communication, while CAN FD might substitute for CAN in the powertrain and body domain. An optional central gateway (CGW) connects the domain with the outer world.

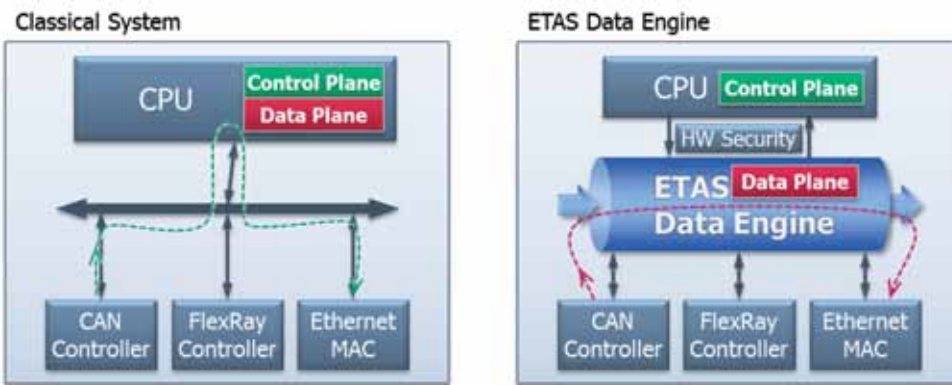

Figure 7: Left: In a classical approach the data and control plane are implemented in firmware. The CPU controls the communication controller. Right: The Etas Date Engine implements the data plane in hardware. The CPU controls the hardware engine.

the power consumption. Real-time communication generally demands low latency, low jitter and high determinism. Low latency communication is achieved by transmitting the data in short frames, leading to high event rates. High event rates lead to high interrupt rates and the system efficiency decreases.

In classical implementations the control and data plane are both implemented in software on a CPU and will not keep up with the new demands in terms of performance and power consumption. A solution is the introduced Etas Data Engine (EDE). The EDE is an FPGA-based IP-core for high data traffic handling. The CPU only controls the EDE and is unburdened from data transport tasks. The EDE allows a latency of less than 5  $\mu$ s with

negligible jitter, as well as a throughput of up to 3 Gbit/s [3]. A possible deployment of the EDE is a gateway controller that is responsible for translating protocols between network domains with minimum delay. This solution is suited for design of gateways. To reduce the number of ECUs in the vehicle, the gateway functionality can be combined with domain-specific ECUs. The company is going to offer the data engine on the open market and for high-volume production based on an IP-Core license model.

The introduction of Automotive Ethernet to the vehicle and the increasing connectivity between vehicle and outer world drives the discussion towards possible illegal access to the vehicle's network (hack attacks). A possible future

enhancement of the EDE could cover this aspect by adding a hardware security module (e.g. SSL (secure sockets layer) protocol in hardware). ◀

## Outlook

The long-term trend towards electric mobility and the associated electrification of the powertrain, as well as the idea of vehicles interconnection with the environment (car-to-car, car-to-X), are a catalyst for a change in the communication architecture for the vehicle of the future. The vehicle communication is becoming increasingly important and is thus a driving factor for innovation.

Due to increasing requirements in terms of bandwidth, flexibility, and economy of networking systems, the demand for using network technologies with high bandwidth, such as Internet Protocol and Ethernet, will increase. CAN FD is a promising bridge in terms of bandwidth, cost, and migration effort towards this future.



# Safe-guarding CAN FD for applications in trucks

Marc Schreiner, Helmut Leier, Matthias Zerzawy, Tobias Dunke, Jürgen Dorner

## Authors

Dr. Marc Schreiner  
Dr. Helmut Leier  
Daimler Research & Development  
Wilhelm-Runge-Str. 11  
DE-89081 Ulm

Matthias Zerzawy  
Tobias Dunke  
Jürgen Dorner  
Daimler Trucks  
Mercedesstr. 123  
DE-70327 Stuttgart

## Link

[www.daimler.com](http://www.daimler.com)

## Abstract

This article gives an overview about safe-guarding CAN FD for applications in trucks. The present situation of CAN networks in Daimler trucks is described. Furthermore capabilities and implications for the future usage of CAN FD in truck architectures are shown from the physical layer point of view.

Daimler Trucks was among the very first adopters of the CAN networking technology. In the beginning of the 1990s CAN was introduced into the SK (schwere klasse: heavy class) truck. In the first application (Euro 2 engines) there were only two CAN ECUs (electronic control units) running at 125 kbit/s with a special truck low-speed physical layer (ISO 11992). Since then, with every step in the evolution of the electronic architecture the number of CAN networks, CAN ECUs and the total amount of transmitted data increased as shown in Figure 1. In the current architecture ("New Actros"), which was introduced in 2011, there might be up to 12 CAN networks in one vehicle (depending on the vehicle configuration ordered), the bit-rate is at least 500 kbit/s and on some dedicated CAN networks it is in-

creased to 667 kbit/s. The Figure 1 shows that also in the time between steps in architecture there is an increase of data transmission due to features that have to be added to an existing architecture.

## Networks for future truck architectures

For the next step in truck architectures, networks running only with classic CAN will not be able to keep up with the growing demand for the bandwidth. More powerful networking technologies that could be used in future truck architectures are CAN FD (a further development of the CAN protocol), Flexray (already successfully introduced into passenger cars), and Ethernet (Broadcom automotive 100-Mbit/s Ethernet that is just about to have its debut in passenger cars). Figure 2 gives a comparison of prop-

erties of classic CAN with CAN FD and Flexray dedicated for trucks (for passenger cars it may differ). Since the automotive version of Ethernet is a switched networking technology that does not support shared media, it is not included into this comparison. The overview distinguishes between CAN with  $\leq 500$  kbit/s (the past at Daimler Trucks) and CAN with  $\geq 500$  kbit/s (the present situation at Daimler Trucks).

The main aspects are:

- ◆ Bandwidth: Classic CAN will not provide enough bandwidth in future. CANFD will increase the available bandwidth. Flexray would have the most potential with respect to bandwidth.
- ◆ Cost: It can be expected, that CANFD will cost approximately as much as classic CAN. Flexray would be more cost intensive due to additional

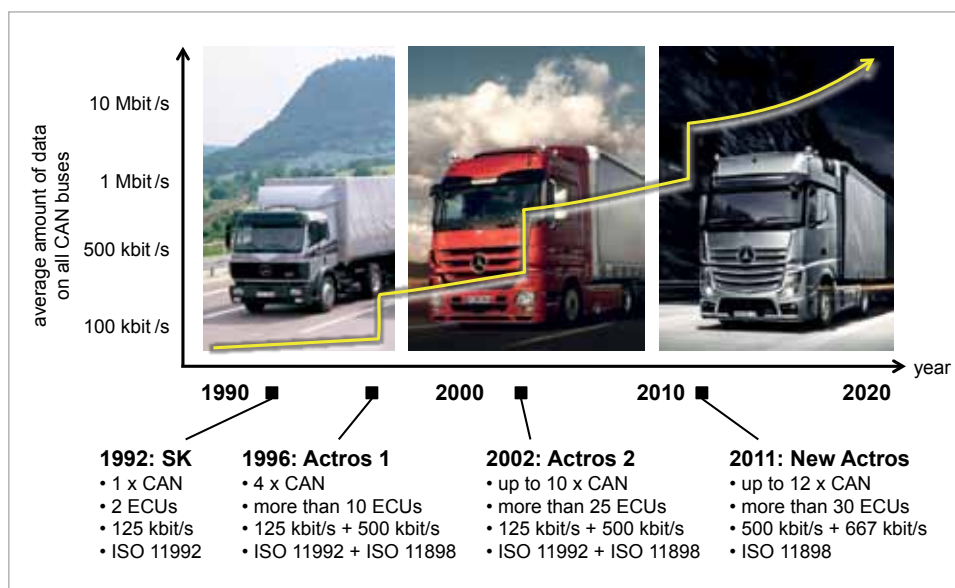

Figure 1: Evolution of CAN networks at Daimler Trucks





PCIe  
CAN Interface



USB  
CAN Interface

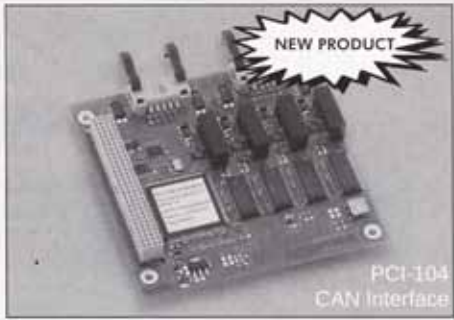

PCI-104  
CAN Interface



PCI  
CAN Interface

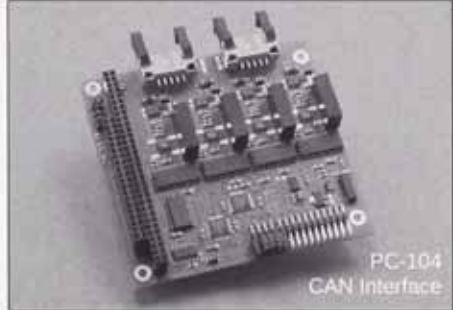

PC-104  
CAN Interface



Ethernet  
CAN Interface

## CAN Interfaces for Your Requirements

- Economical solutions for series applications
- Optimized for industrial applications
- Solutions for stationary and mobile use
- Software support for bus-analysis, measurement and control

[www.ems-wuensche.com](http://www.ems-wuensche.com)

**EMS** Sonnenhang 3  
D-85304 Iilmünster  
Tel. +49-8441-490260  
Thomas Wünsche Fax. +49-8441-81860

Visit us at BAUMA  
Hall A5, Stand 307

## ADVANCED CONTROL SYSTEM PRODUCTS FOR TOUGH, RUGGED AND EXTREME CONDITIONS



### EPEC 5050 CONTROL UNIT

BASED ON 32 BIT PROCESSOR

MEMORY:

- FLASH 8 MBYTE
- RAM 4 MBYTE / 8 MBYTE
- NON VOLATILE: 512 KBYTE
- PLCOPEN APPLICATION MAX SIZE
  - 1 MBYTE / 3 MBYTE
- TEMPERATURE RANGE -40°C ... +70°C

### EPEC 3606 CONTROL UNIT

BASED ON 16/32 BIT PROCESSOR

MEMORY:

- FLASH 1,6 MBYTE
- RAM 1 MBYTE
- PLCOPEN APPLICATION MAX SIZE
  - 768 KBYTE
- TEMPERATURE RANGE UP TO +85°C

### EPEC 3724 CONTROL UNIT

BASED ON 16/32 BIT PROCESSOR

MEMORY:

- FLASH 1,6 MBYTE
- RAM 1 MBYTE
- NON VOLATILE: 8 KBYTE
- PLCOPEN APPLICATION MAX SIZE
  - 768 KBYTE
- TEMPERATURE RANGE UP TO +85°C





Architecture based on:	CAN2.0B ≤ 500kbit/s	CAN2.0B ≥ 500kbit/s	CAN2.0B + CANFD	CAN2.0B + FlexRay
Bandwidth	--	0	+	++
Cost	++	++	++	0
Limitations for truck topology – Possible line lengths	+	--	+	+
Flexibility over vehicle lifespan	0	+	++	0
Flexibility for vehicle diversity	++	++	++	0
Hardware availability	++	++	2016 ?	+
Diagnosis / Flashing	--	0	++	+

Figure 2: Comparison of CAN, CAN FD and Flexray for trucks

expenses for software and physical layer.

- ◆ Transmission line length: For trucks and especially omnibuses the possibility to use long transmission line lengths is an important criterion. CAN using up to 500 kbit/s allows for adequate transmission line lengths, whereas CAN with more than 500 kbit/s is significantly limited with respect to transmission line length. CAN FD and also Flexray will allow for longer transmission line lengths comparable with the classic CAN networks running at up to 500 kbit/s.
- ◆ Flexibility: In the electronic architecture from the truck it has two dimensions. Firstly, truck architectures have a long life span (might be twice the life span of a passenger car architecture), in which they have to be extendable for new features or regulations. CAN FD would maintain flexibility in this case because it is as easy to handle as classic CAN and provides enough bandwidth. Flexray requires a complete pre-definition of the communication schedule, which could be a difficult and ineffective job with regard to future exten-

sions. Secondly, there is a broad diversity of different vehicles (light trucks, heavy trucks, omnibuses, special-purpose vehicles etc.) and markets (Europe, North America, South America, Asia etc.). The intention is to reuse the core of the electronic architecture for all vehicles and markets and to adopt it to the respective needs. This can be handled flexibly using CAN or CAN FD, however finding one common Flexray communication schedule would be a challenging job. Working with vehicle-dependent communication schedules would be even more complicated.

- ◆ Hardware availability: It is very good for CAN and is also good for Flexray. There are promising announcements for com-

ing CAN FD products.

To use these in the next architecture step these products have to be ready for production in 2016.

- ◆ Diagnosis and flashing: Flashing can be quite slow using classic CAN. It could be accelerated significantly using CAN FD especially due to the extended payload frames. However this requires that the link into the vehicle also supports CAN FD. Using Flexray, the flashing speed depends mainly on the design of the communication schedule.

### Signal integrity of truck CAN physical layer

The question has to be answered whether CAN FD will be suitable for the physical characteristics

of truck and bus architectures. To give a first estimation of the obtainable bandwidth, two example topologies taken from real vehicles are examined. The example is taken from one of the five main CAN networks of the vehicle. It is connecting ECUs on the truck as shown in Figure 3. There is one common electronic architecture for all vehicles using the same type of ECUs performing the same functions. However, depending on the vehicle type, the physical structure of the topology can be very diverse. The example truck topology (9-m vehicle) uses a classic CAN network with stubs in this case. In an articulated bus (20-m vehicle) it is a passive double star topology.

Typical characteristics of truck and omnibus topologies are long transmission line lengths (up to 50 m between two ECUs) and large number of ECUs within one vehicle and within one physical CAN network. CAN allows to handle the variety of topologies, but the physical layer in large topologies is challenging. Figure 4 shows the structure of the example topologies in detail on the left side. On the right side a CAN signal integrity graph is shown, which can be used to evaluate the physical characteristics of a CAN topology. The articulated bus topology might also have some optional ECUs (not shown in Figure 3). All calculations are based on the topology shown in Figure 4.

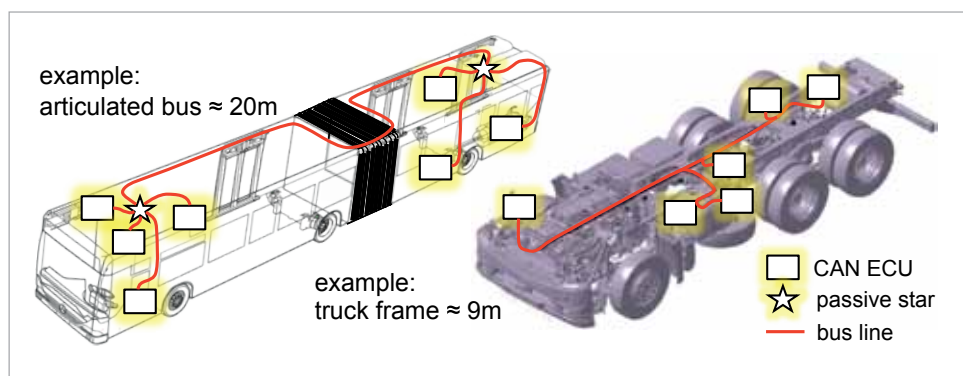
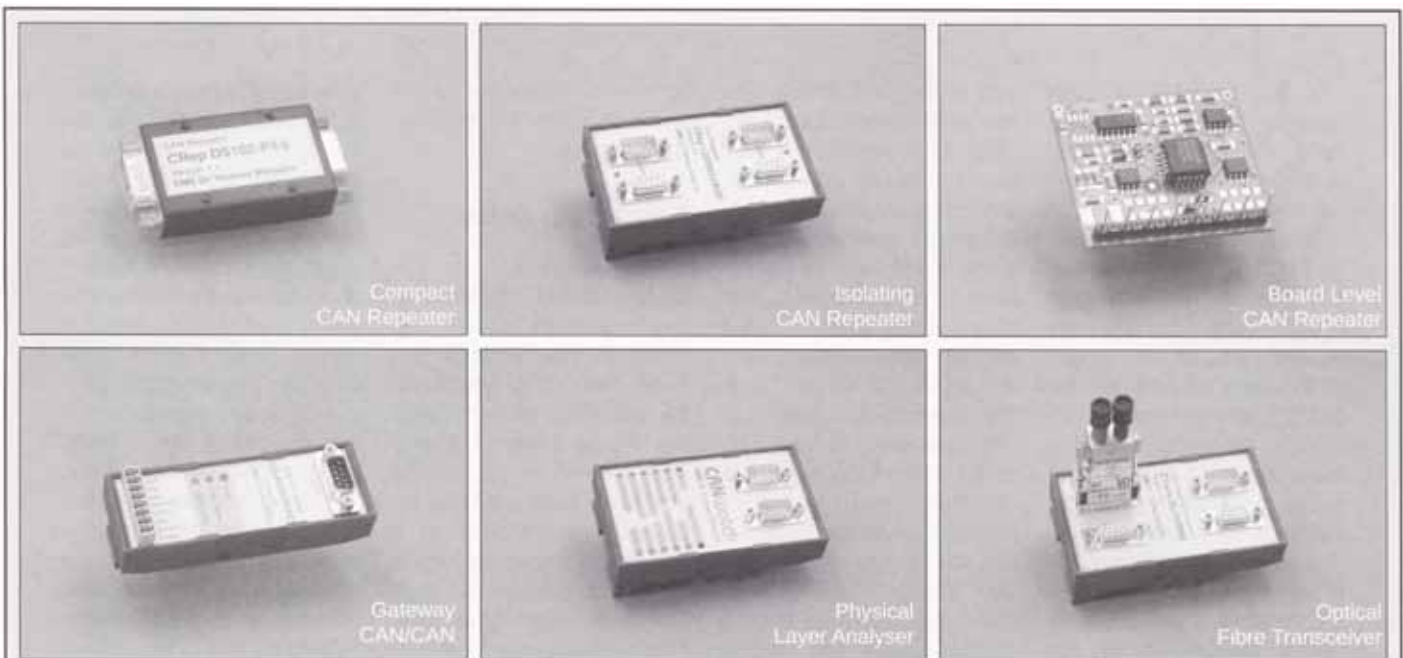

Figure 3: Example truck and omnibus architecture



## CAN Network Technology

Successfully applied in

- Machine automation
- Building automation
- Transportation systems
- Telecommunication systems

[www.ems-wuensche.com](http://www.ems-wuensche.com)

**EMS** Sonnenhang 3  
 D-85304 Iilmünster  
 Tel. +49-8441-490260  
 Thomas Wünsche Fax. +49-8441-81860

## Automotive Electronics Smart and innovative IP solutions for embedded systems

**Bosch offers a broad portfolio of IP modules for automotive and industrial application.** Our certified IP modules are ready for integration, making the perfect adaption of micro-controllers to your needs easy.

**The Bosch IP product range includes:**

- ▶ communication controller IPs for CAN, LIN and FlexRay bus
- ▶ scalable timer modules for flexible use in multiple domains

Visit our booth at embedded systems in Nuremberg and see CAN FD live demo. Find out more at:

[www.bosch-semiconductors.com](http://www.bosch-semiconductors.com)



**BOSCH**

Invented for life



To evaluate a CAN topology dozens of signals have to be checked and, if done manually, the worst-case signal might be missed. Therefore Daimler R&D developed the signal integrity graph (Figure 4 right side). One topology is described in one graph that shows all relevant topology characteristics including the worst-cases. In order to get the signal integrity graph all physical signal relationships between all nodes in the network have to be measured or simulated. All analog bus and digital Rx (receive) signals are synchronized on the falling edge of the Tx (transmit) signal and plotted in an intersected manner. The re-

sult shows two areas: The red area comprises all analog bus waveforms that can be found in the network; overshoots, ringing or the shape of the transitions from dominant to recessive can be examined. The blue-shaded area includes all Rx signal slopes relative to the Tx slope. Thus, the position and extent of the blue-shaded area directly corresponds to the minimum and maximum propagation delay between the nodes. The truck topology shows comparatively clean bus signals, ringing decays quickly and there is only a little delay. However the articulated bus topology shows more ringing, reflections and it has consider-

ably more delay due to the more complex structure of the topology.

### Round trip delay

A relevant value for the CAN protocol controller is the maximum round trip delay in the network between the ECUs, which can be extracted directly from the signal integrity graph. The maximum round trip values of both example topologies are plotted in a bar graph shown in Figure 5. They represent the typical case (light blue bar). For worst-case estimations, the temperature-dependent tolerances of the transceiver and EMI (electromagnetic interference)

jitter have to be considered (grey bars) and the CC delay (dark blue bar) has to be added. Oscillator tolerances in the ECUs have a similar effect that can be expressed as an additional delay; the respective values are added as grey bars at the sample point positions. In the example (Figure 5) a direct clocking of the controller by a crystal is assumed. In case a PLL (phase-locked loop) clock is used, the clock tolerance might be larger. The maximum bit-rate in the network is limited by the maximum round trip delay. It has to be smaller than the time position of the sample point within one bit-time. If the round trip delay is too large, the arbitration and acknowledge mechanism does not work anymore resulting in error frames on the network. These limits are shown in Figure 4 for different bit-rates and sample points.

The resulting safety margins in Figure 5 show, that the truck topology would work with 800 kbit/s, though only with a small safety margin. The articulated bus topology will only work safely with 500 kbit/s. This calculation shows that in trucks and omnibuses the maximum acceptable bit-rate (500 kbit/s and 667 kbit/s) is already reached. Further increase with the classic CAN network will

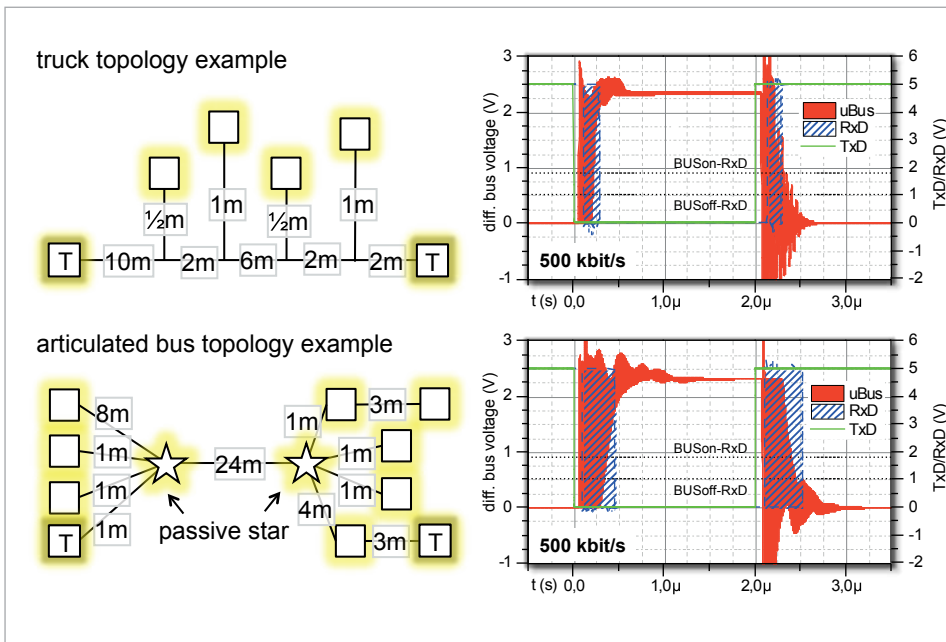

Figure 4: Truck and omnibus topology with signal integrity graph

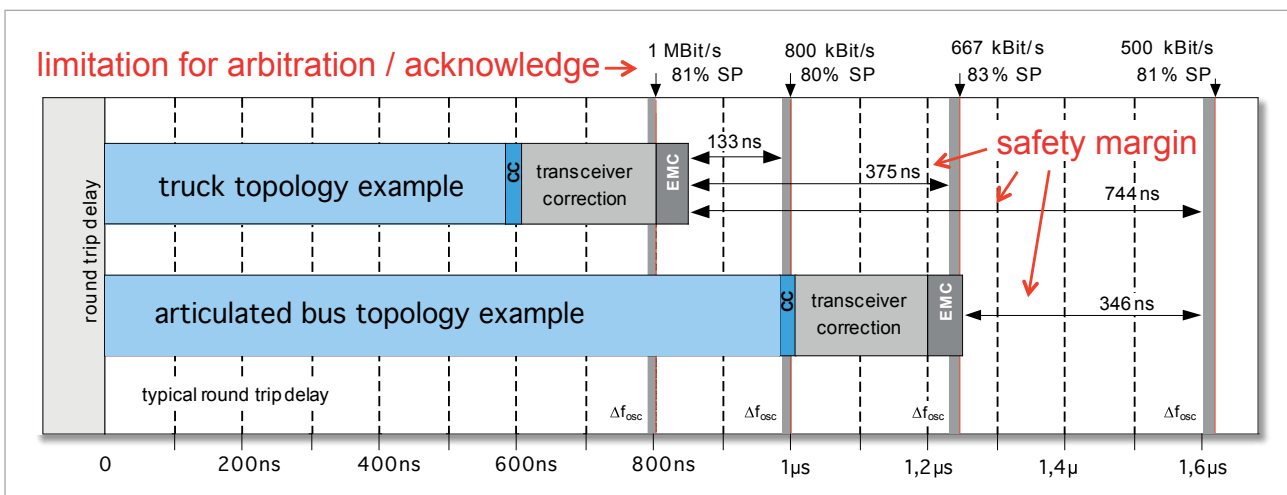

Figure 5: Round trip delay and bit-timing



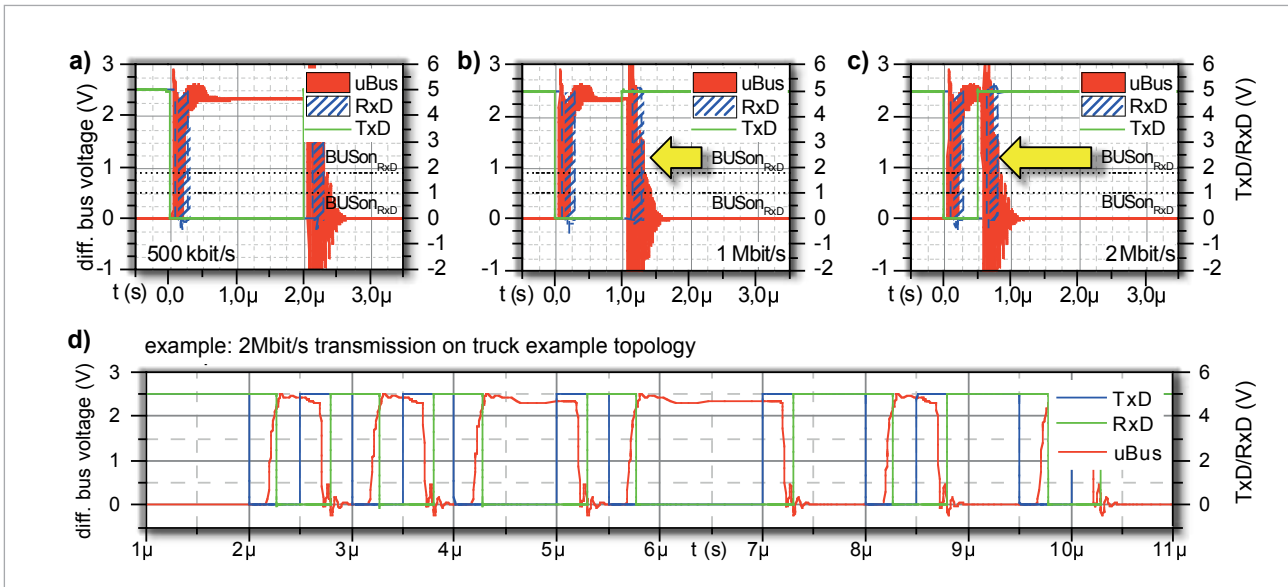

Figure 6: Signal integrity graphs

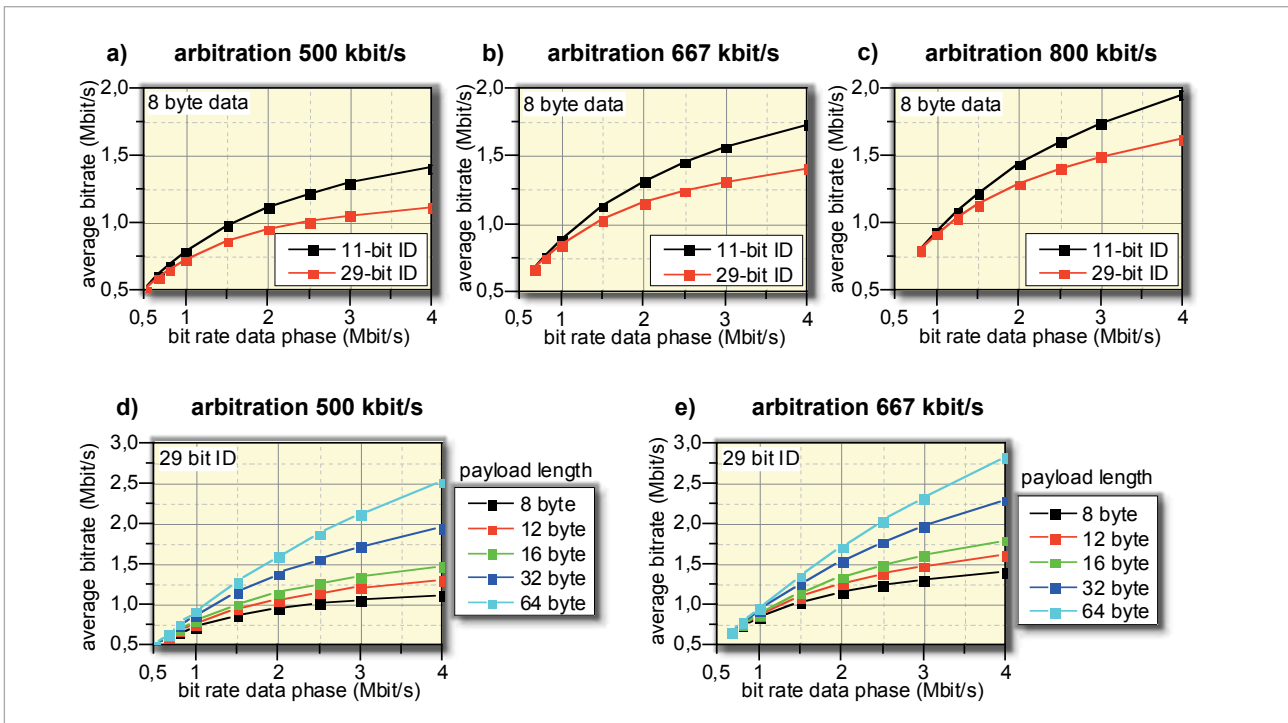

Figure 7: Average bit-rate with CAN FD protocol

not be possible. The limiting factor is the round trip propagation delay between the nodes.

### The potential of the CAN FD physical layer

However, today's CAN physical layer (high-speed) has the potential for higher speeds. The bit-rate is only limited by the arbitration and acknowledge mechanism, not by signal integrity on the network. CAN FD can overcome the bit-timing bot-

tleneck of classic CAN enabling more data throughput without changing topologies and physical layer hardware. Figure 6 shows what happens to the CAN signals when the bit-rate is accelerated, e.g. in the fast data phase of a CAN FD frame. The calculation uses the truck example topology (Figure 3 and Figure 4). The signal integrity graphs show an increase of the bit-rate from 500 kbit/s to 1 Mbit/s and finally to 2 Mbit/s (Figure 6a to Figure 6c). It can be seen that the shape of the slopes

does not change and the relative delay time stays the same. Only the steady state part of the bit is contracted. The lower graph in Figure 6d shows a detail of a CAN bit stream with 2 Mbit/s in the example topology. It can be seen that the analog waveforms as well as the digital Rx signals are well transmitted over the physical layer. At approximately 2 Mbit/s, the extent of the bit in relation to the extent of the signal slopes shows, that a further increase would not be reasonable.

The first simulation results show, that even in truck and omnibus topologies approximately up to 2 Mbit/s for the data phase of the CAN FD protocol would be possible using the current transceivers and current topology structures. For the arbitration phase today's common bit-rates of 500 kbit/s to 667 kbit/s have to be maintained to ensure correct arbitration and acknowledge. Of course, these theoretically calculated results still have to be confirmed by mea- ▶

measurements with real hardware.

### Increased data throughput with CAN FD

The calculations above give a first estimation of possible arbitration phase and data phase speeds in the CAN FD message. These values permit to estimate the average data throughput that can be achieved with CANFD under these physical layer conditions. The upper three graphs in Figure 7 are plotted for arbitration speeds of 500 kbit/s to 800 kbit/s. The horizontal axis represents the bit-rate in the fast data phase of a CAN FD frame, while on the vertical axis the resulting average bit-rate is plotted, assuming that only 8 byte payload frames are used. In this case no changes to the application software would be necessary when using CAN FD, besides an adoption of the CAN driver software. Figure 7a shows that the average bit-rate could be nearly doubled for an arbitration speed of 500 kbit/s and 2 Mbit/s for the data phase using only 8-byte data frames and the 29-bit CAN-IDs (identifiers), which is common in trucks. There could be more gain in average bandwidth for networks using the 11-bit CAN-IDs e.g. in passenger cars. The

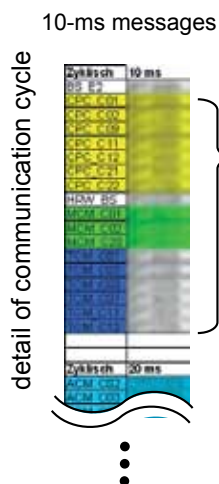

CAN (29-bit CAN-ID) 667 kbit/s	CAN FD std. arb. 667 kbit/s data 2 Mbit/s 8-byte frames only	CAN FD extd. arb. 667 kbit/s data 667 kbit/s 64-byte frames	CAN FD extd. arb. 667 kbit/s data 2 Mbit/s 64-byte frames
18 x 8-byte msg. 3,537 ms	18 x 8-byte msg. 2,088 ms	2 x 8-byte msg. 0,405 ms	2 x 8-byte msg. 0,232 ms
		1 x 32-byte msg. 0,497 ms	1 x 32-byte msg. 0,214 ms
		1 x 48-byte msg. 0,689 ms	1 x 48-byte msg. 0,278 ms
		1 x 64-byte msg. 0,881 ms	1 x 64-byte msg. 0,342 ms
<b>Σ 3,537 ms</b>	<b>Σ 2,088 ms</b>	<b>Σ 2,472 ms</b>	<b>Σ 1,066 ms</b>

estimation not including stuff bits...

Figure 8: Example of different CAN FD configurations

estimation does not include stuff bits.

Apart from the faster bit-rate in the data segment, CAN FD also enables transmission of frames with a payload of up to 64 bytes. The two lower graphs in Figure 7 show the effect of the extended payload length, assuming that all transmitted frames make completely use of the respective payload. It is evident, that the gain in average bit-rate is maximized when frames with long payload are used. For example, in a truck network with an arbitration speed of 500 kbit/s and a data-phase speed of 2 Mbit/s with 8 bytes of payload would make a little less than a 1-Mbit/s aver-

age bit-rate. However, when using the whole 64 bytes of the payload, the yield is a little higher than a 1,5-Mbit/s average (Figure 7d). This means an increase of approximately 50 % of the average bit-rate. Also this estimation neglects stuff bits. Using more than 8 bytes of payload will have a direct impact on the applications and the ECU's operating system as these are currently developed to deal with 8 bytes of payload only. Especially applications using the J1939-based protocols and vehicle flashing applications could benefit from the extended payload length.

Figure 8 shows an example, which is taken from a real truck communication cycle. Only the messages that are transmitted cyclically every 10 ms are shown. Some ECUs need to transmit more than 8 bytes of payload resulting in a burst of frames that take approximately 3,5 ms to be transmitted. Figure 8 shows the reduction in transmission time achievable using CAN FD with an 8-byte payload and fast transmission of the data, with extended payload but without fast transmission of the data and with both mechanisms combined. In all configurations CAN FD reduces the necessary transmission time

and allows more data to be transmitted on the network.

### Next steps

In order to safeguard the CAN FD technology for the integration into vehicles, real hardware for testing is necessary. Until now micro-controllers with integrated CAN FD controller are not available. A CAN FD IP is already available from Bosch as a VHDL code. Therefore Bosch, Daimler and NXP jointly developed a sample gateway device based on an FPGA implementation. It can be used to build up entire CAN FD networks and perform hardware tests of topologies, signal integrity and EMC as well as software tests such as gateway algorithms. According to the company, the ECU in Figure 9 represents the world's first CAN FD-compatible ECU suitable for usage in vehicles. It is powered by a 32-bit CPU from Renesas running with Autosar. Two CAN FD IP cores are running on an Altera FPGA, which is interconnected to the CPU using the memory bus. Different CAN transceivers are included and selectable for CAN FD or classic CAN. The power supply unit, connectors, size and housing are designed to use it in a laboratory or vehicle environment.

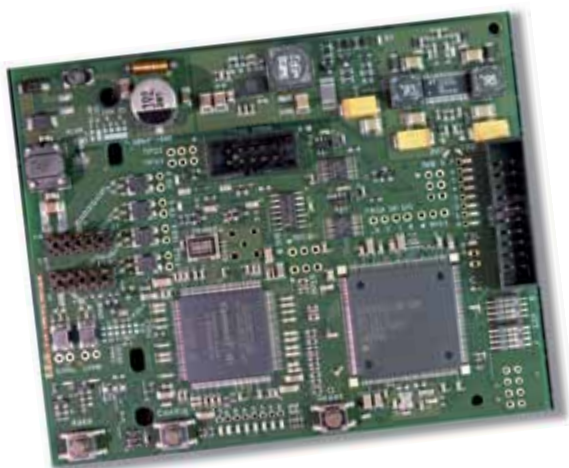

Figure 9: CAN FD sample gateway device

The sample gateway device will be used to confirm the first simulation results given in this article. Furthermore it will be used to perform various investigations to answer open questions and finally derive design rules for the CAN FD networks. It is not intended to go into series production and will only be used for R&D purposes. Some of the topics to be investigated are:

- ◆ Clock/jitter tolerance
- ◆ EMC emissions
- ◆ Robustness against EMC
- ◆ Robustness of transceiver delay compensation
- ◆ Signal integrity, asymmetric delay
- ◆ Qualification of transceivers
- ◆ Interoperability of different bit-time and clock settings
- ◆ Interoperability of different controllers
- ◆ Software tests
- ◆ Gateway strategies

A final validation of the CAN FD technology and its possibilities will be made when it has passed these tests.

## Conclusion

CAN FD is a promising bus technology that allows designing cost-optimized and flexible architectures for trucks and omnibuses in the future. First estimations show that in typical truck and omnibus networks bit-rates in the data field of approximately 2 Mbit/s would be possible without changing the physical layer and the network topology. In combination with the extended payload the average data throughput could be increased by a factor of three depending on the application. The main advantage of CAN FD for trucks is the increase of average data throughput for the applications, which will maintain flexibility for future extensions and diversity of

vehicles. This enables extension of the life time cycle of existing electronic architectures.

At Daimler, CAN FD currently has the status of a predevelopment project. To use CAN FD in the next vehicle generation in approximately 2016 and 2017, a dependable roadmap of micro-controllers with included CAN FD IP must be available by mid of 2013. Especially, the availability of a micro-controller suitable for gateway applications with at least four CANFD controllers is a precondition for the series introduction. ◀

**i** **INTER  
CONTROL**

*digsy*<sup>®</sup> fusion

**- the safety  
controller**

**advanced + safe**

PL d Cat. 3 according to EN ISO 13849

**powerful + safe**

redundant 32 bit CPU and FPU

**flexible + safe**

safe I/O extensions

**adaptable + safe**

safe and standard program

w/o feedback



**bauma  
2013**

hall A4, booth 323

Register now  
for the premiere at:

[www.intercontrol.de/en/bauma](http://www.intercontrol.de/en/bauma)

[info@intercontrol.de](mailto:info@intercontrol.de)

Tel. +49 911 9522-851

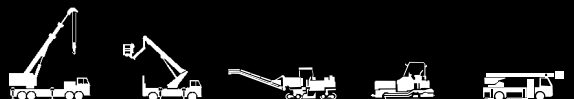

# Inventor presented the improved CAN data link layer

## Links

[www.bosch.com](http://www.bosch.com)  
[www.vector.com](http://www.vector.com)

## Introduction

This article provides detailed information of the presentation about CAN FD, which was given on 29<sup>th</sup> November by Thomas Lindenkreuz from Robert Bosch.

It reports about the CAN FD benefits and the use cases for the improved CAN protocol. The article also informs about the already available components.

Thomas Lindenkreuz, the Director for the development of digital ASICs and IP modules at Robert Bosch, Automotive Electronics, Development Division Semiconductors gave a presentation about CAN with flexible data rate. He has been working for Bosch since 1990 in various functions and is one of the CAN FD inventors. According to Mr. Lindenkreuz, CAN FD has already achieved a degree of maturity, which shows that the improved CAN technology has a successful future. Interest in the improved CAN technology and company's CAN FD demonstrator at the tabletop exhibition accompanying the congress, resulted in a full hall of listeners.

After a historical overview of CAN development, the performance comparison of diverse automotive network technologies was presented. Figure 1 indi-

cates the network's possible bandwidth relationship to the implementation costs per node. The evaluation shows that CAN FD would de facto not cause additional costs regarding the hardware at the same time offering the traditional CAN technology benefits. The bit-rate achievable by CAN FD rises into the area, which is currently covered by Flexray. According to company's discussions with the Asian carmakers, Flexray with bit-rates of 2,5 Mbit/s and 5 Mbit/s is rather used for emulation of CAN on the Flexray networks as for the time-controlled communication. Introduction of CAN FD would make these practices obsolete. In his presentation on the congress, Mr. Röder from Continental has even predicted that Flexray will disappear from the future car electronic architectures, so that only CAN, LIN and Ethernet will be used.

## CAN FD basics

The CAN FD idea is to transmit the bits within the data phase of a CAN frame with a higher bit-rate as in the arbitration and the acknowledge parts. If the length of a CAN FD frame's data field stays at 8 bytes, no changes in the software have to be made. Of course, the whole network should be configured as a CAN FD network, but from the software side it looks, as it would be the classic CAN communication. The difference is the faster data transmission. This led the developers of CAN FD to the idea to increase the amount of bits transmitted while the data phase. The 64-byte length was chosen, because it seemed to be a value comfortably realizable in the practice. The data field could be clocked eight times faster. This would result in a CAN FD message with 64 data bytes, which lasts approximately as long as the classic CAN message (with 8 data bytes) transmission. Thus, the whole network design would be de facto not disturbed.

A CAN FD frame (Figure 2) makes use from the EDL (extended data length) bit in the control field, which was reserved for future use by the "prime fathers" of CAN. The recessive EDL-bit state indicates a CAN FD frame while the dominant EDL state (as it was hitherto) indicates the traditional CAN frame. In the first case, the control field additionally indicates whether the

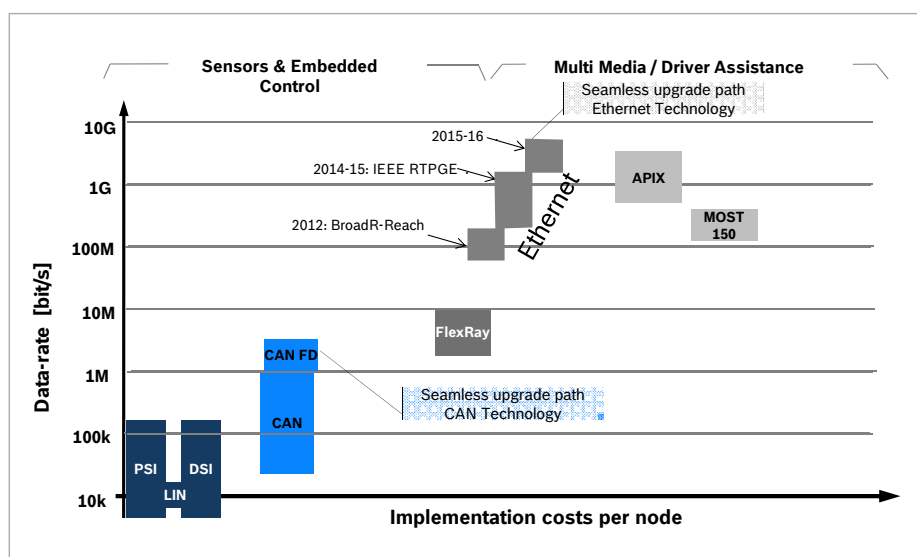

Figure 1: Possible bandwidth relationship to the implementation costs per node for automotive networks



# Industrial Computing Architects



## 30 years of experience in industrial computer systems

Janz Tec AG, has been one of the leading manufacturers of electronic assemblies and complete industrial computer systems since 1982. The company describes itself as *Industrial Computing Architects* and develops embedded PCs, industrial computers and industrial communication according to customer requirements.

Good communication is very important nowadays – not just in real life, but also in machines, plant and complex industrial applications from a wide range of industries. This applies especially if error-free transmission of data is required due to more and more compact construction and the necessity for more performance in

the case of distributed systems. For this reason, Janz Tec AG also places great value on innovative and sophisticated technology in the industrial communication business sector. The InCom products developed in-house enable the control systems for your machines, plant and systems to be kept at the highest level.

With 30 years of experience in the market, Janz Tec AG is capable of meeting individual customer requirements at any time – this starts as early as the concept phase, continues through the development and production of the components up to series delivery.

**janztec**  
Industrial Computing Architects

**6<sup>th</sup> Vector Congress**

End of November 2012, Vector Informatik organized the 6<sup>th</sup> two-day Vector Congress in Stuttgart (Germany).

Up to 300 people came to the event and met engineers mostly coming from the automotive electronics branch. Several CAN-relevant topics were presented in the area of diagnostics (Vector, Müller), heavy-duty vehicles (Volvo, Niemczyk; Caterpillar, Weck; Vector, Fellmeth), ECU testing (Bosch, Kempe), Autosar safety (Peiker, Müller) and the new bus systems (Continental, Röder; Bosch, Lindenkreuz). The released presentations are available from company's website at [https://www.vector.com/vi\\_congress12\\_en.html](https://www.vector.com/vi_congress12_en.html).

...

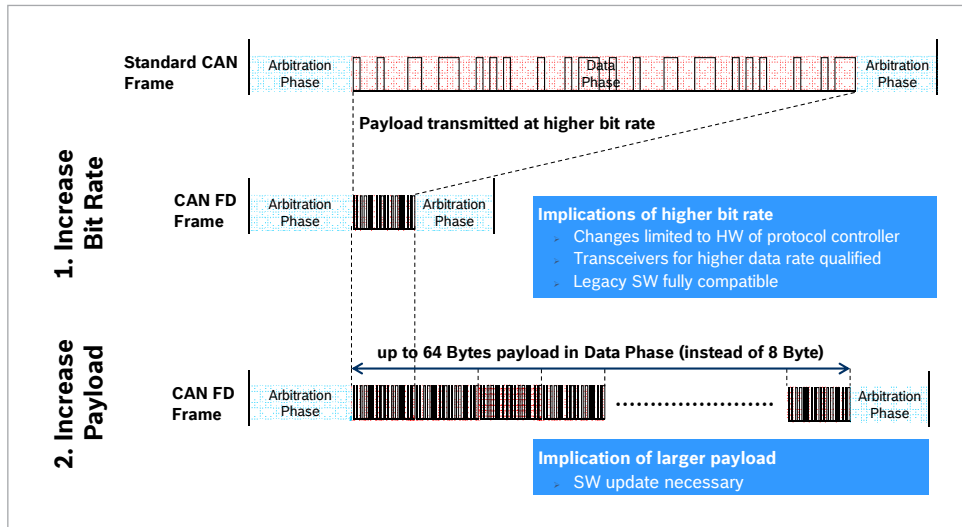

Figure 2: CAN FD frame

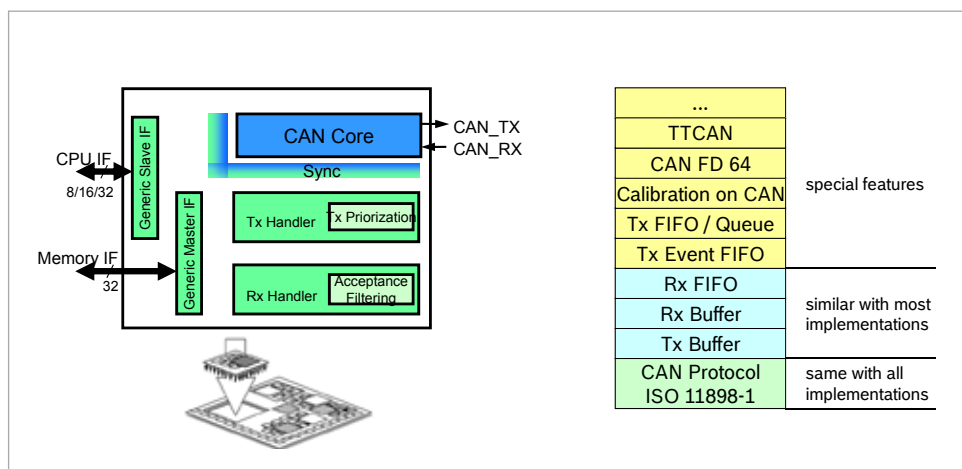

Figure 3: Architecture of the M\_CAN communication controller

bit-rate in the data field will be switched and in which error state (passive or active) the transmitting node is currently. Additionally, the coding of the DLC (data length code) and the CRC (cyclic redundancy check) is changed with regard to a longer data field.

Mr. Lindenkreuz also shown, how the average message bit-rate varies depending on the length of the data field (payload). Using the arbitration bit-rate of 1 Mbit/s and the data-field bit-rate of e.g. 6 Mbit/s results in average bit-rates of ca. 2,5 Mbit/s (8-byte payload) up to ca. 5 Mbit/s (64-byte payload).

**Possible use cases**

Common use cases include a fast software download. An example calculation comparing classic CAN

(500 kbit/s, 8 data bytes) transmission of 32 payload-bytes with CAN FD (2 Mbit/s, 32 data bytes) shows that with CAN FD a four-times faster transmission of the intended payload is possible. Bosch's internal usage interest is the fast flashing of the ECUs (band end programming). Alone for this purpose, it was reasonable for the company to invent the enhanced CAN technology.

CAN FD transmission also allows to avoid splitting of long messages. For example, data sent from a three-axis acceleration sensor could contain three 8-byte values respectively related to X, Y and Z axes. Using a CAN FD frame, transmission of the three values within one message is possible. This simplifies the handling of data, as it is received for all three axes

without a time offset. This also eases the management on the transport layer. Additionally, longer CAN FD messages allow a secure 8-byte data transmission fulfilled by adding of a MAC (message authentication code) to the data field.

As a data exchange growth in electric vehicles is expected for the next years, CAN FD would fit for the next generation of power train requirements of such vehicles. In case of extreme functional enhancements, use of Ethernet might be necessary.

A further use case allows for faster communication on long bus lines typically found in trucks and omnibuses. These vehicles commonly use the bit-rate of 250 kbit/s and communicate according to the J1939 protocol. As the bit-rate in the data field is in-

creased independent of cable length, average bit-rates of up to 810 kbit/s are estimated to be possible.

### Availability of components

Figure 3 shows the architecture of the M\_CAN communication controller from Bosch. This is available with full CAN FD support (higher bit-rate and 64-byte payload). M stands for modular and means that diverse CAN features may be flexibly combined and passed to company's semiconductor-manufacturers to be integrated on silicon. Interested parties may contact Bosch in order to get a license for the CAN FD-capable M\_CAN modules.

Through cooperation by Bosch, Daimler Truck and NXP, a CAN FD gateway board was created, which could be seen on Bosch's demonstrator at the accompanying exhibition. The board includes a classic CAN controller and an FPGA with two implemented and instantiated CAN FD IP cores. The cores are able to run with up to 10 Mbit/s. Up to three selectable physical layers for CAN FD can be implemented on the board. Regarding the form factor, it was designed to fit into the useful automotive housings. The board also features truck and passenger car compatible connectors. Autosar-based test software for the board is on development. The companies agreed to provide the board (hardware and software) to the third parties beginning with April 2013.

Tools for CAN FD are available from Vector (CANalyzer, CANoe) and from the Bosch's daughter company Etas (e.g. Busmaster). The CAN FD-capable CANoe version was presented by Vector on the accompanying exhibition.

Regarding the hardware, Bosch met a commitment with NXP (at the CAN FD Tech Day in De-

troit) to introduce a CAN FD transceiver roadmap supporting different bit-rates. Also STM and Freescale presented their roadmaps on the CAN FD Tech Day. Thus, it is planned to have micro-controller samples supporting CAN FD with up to 64 payload bytes in the Q1/2013. Bosch is in communication with other semiconductor manufacturers regarding this topic. Mr. Lindenkreuz also mentioned that Bosch's CAN FD micro-controllers will be integrated into company's ECUs starting from 2015 and 2016.

*Olga Fischer*

# POSITAL

## FRABA

### SIL 3 CANOPEN SAFETY



### Safe Single and Multiturn Absolute Position Measurement with CANopen Safety Interface

Compliant with New Machine Directive  
EN2006/42/EC

Highest Safety Standards  
with SIL 3 EN/IEC 62061, Cat.4  
and PL e EN ISO 13849-1

Certified by TÜV Rheinland®

Redundant High Resolution  
Optical Design up to 30 Bit

Customer Advantage:  
No PLC Plausibility Check for  
Position Value Needed

[www.posital.eu](http://www.posital.eu)

POSITAL GmbH  
Carlwerkstrasse 13c, 51063 Koeln, Germany  
T +49 (0)221-96213-0, F +49 (0)221-96213-20

FRABA Inc.  
1800 East State Street, Suite 148,  
Hamilton, NJ 08609-2020, USA  
T +1 609-750-8705, F +1 609-750-8703

FRABA Pte. Ltd.  
60 Alexandra Terrace, #02-05 The Comtech,  
Singapore 118502, Singapore  
T +65 6514 8880, F +65 6271 1792



# Higher flexibility in automotive networks through CAN FD

Radoslaw Watroba, Rolf Nandlinger

## Authors

Radoslaw Watroba  
Rolf Nandlinger

STMicroelectronics  
Application GmbH  
Bahnhofstr. 18  
DE-85609 Aschheim-  
Dornach  
Tel.: +49-89-46006-0

## Link

[www.st.com](http://www.st.com)

## Introduction

The continuous increase of connectivity in automotive networks forces higher data rates. One of the possible solutions to resolve this dilemma is the CAN FD protocol (CAN with flexible data rate). First CAN FD protocol controller implementations integrated in automotive 32-bit micro-controllers are under validation. The semiconductor manufacturers are confronted with new timing requirements to be considered during the system-on-chip integration, which collide with the required current consumption limits. Currently, power train as well as chassis and safety applications are targeted by CAN FD. The carmakers are longing for first implementations for evaluation. The ECU suppliers focus on the reduction of the end-of-line programming times.

The concept behind CAN FD is a transmission of one CAN frame at two speeds. Whereas the arbitration field is transferred at maximum 1 Mbit/s the following payload is accelerated to higher bit-rates e.g. 4 Mbit/s, which is targeted for the first use cases. In contrast to the CAN protocol as defined in the ISO 11898-1 the maximum payload length according to CAN FD has been extended from 8 bytes to 64 bytes. Delays caused by the mandatory network idle times and delays due to the arbitration process are avoided increasing the average data rate as well.

1 Mbit/s is often mentioned as the upper limit for CAN networks. However, the experienced and practiced bit-rate in automotive environments is 500 kbit/s. A robust arbitration and data transmission of the non-deterministic communication is linked to constraints, which have to assure the worst acceptable electrical signal integrity. In addition, automotive networks reflect years of deep experience, therefore, in the most cases, a migration to a CAN FD network in terms of using higher bit-rates should not be assumed. However, customers lacking bandwidth and not willing to go above 500 kbit/s consider the 64-byte payload as an attractive feature of CAN FD.

The CAN FD protocol was also developed to close the gap between CAN (max. 1 Mbit/s) and Flexray (max. 10 Mbit/s). The latter needs

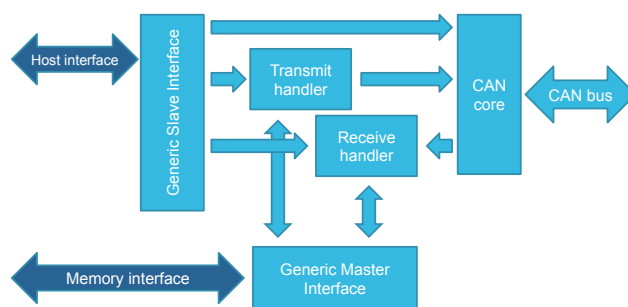

Figure 1: M\_CAN module

dedicated transceivers. Until the new generation of CAN transceivers supporting bit-rates higher than 1 Mbit/s will be available, the use of actual transceivers in mass production at lower data rates is obligatory. Concerning programming with higher switching frequency, the semiconductor manufacturers were requested to modify their actual transceiver specifications and increase the upper bit-rate limit for this use case. The CAN FD introduction requires at least the use of a CAN-FD-capable protocol controller, in fact in each CAN node. Otherwise the communication would break down due to CRC (cyclic redundancy

check) errors interpreted by CAN controllers according to ISO 11898-1 during the CAN FD mode. In April 2012 Robert Bosch has released the CAN FD protocol specification v. 1.0. The goal is to transfer that protocol specification to an ISO standard. Since some open questions still exist, for instance, regarding the physical layer parameters or conformance testing, working groups with individual focus were initiated by the CAN in Automation (CiA) organization.

## First CAN FD protocol controllers

The decision to implement a CAN FD protocol controller was made very early. ▸

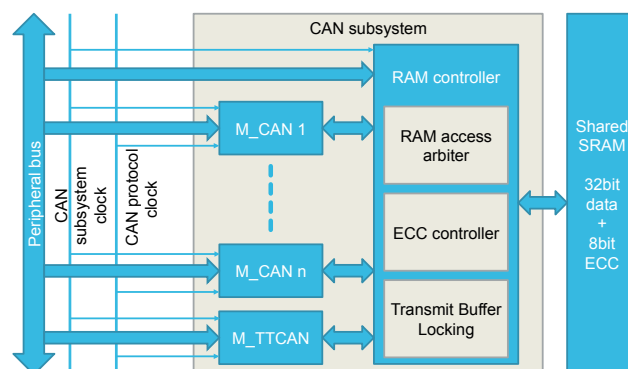

Figure 2: SPC57 CAN sub-system

CONTROLS

# Ethernet Controller EC1000

Compact PLC controller  
with CODESYS 2.3 or 3



Our EC1000: A strong CODESYS controller for the modular CANtrol EC control system. The high performance EtherCAT I/O modules are lined up directly next to the PLC controller. The EC1000 offers state-of-the-art industrial Ethernet technology combined with a **CAN/CANopen** interface. It is a control platform which combines tried and tested CAN components with state-of-the-art EtherCAT modules to create an optimal control solution.

- Optimal performance with EtherCAT up to the I/O terminal
- Easy visualisation with CODESYS Visu and Berghof Ethernet terminals
- Fast connections with Ethernet/EtherCAT®, CANopen and serial
- EC1000 starter package with CODESYS V3. Information at: [www.berghof.com/starterpaket](http://www.berghof.com/starterpaket)



We are exhibiting at:  
Hall 9 | Stand D62

Berghof Automationstechnik GmbH  
Harretstrasse 1  
72800 Eningen | Germany  
[www.berghof.com](http://www.berghof.com)



Currently, STMicroelectronics is developing the SPC57 32-bit micro-controller family based on the 55-nm and 40-nm in-house embedded flash technology for power train as well as chassis and safety applications. Bosch's M\_CAN IP was chosen. Internal validation of the first silicon and therefore of the CAN FD protocol on a target hardware supporting 8-byte payload has been started. Meanwhile the M\_CAN IP has been refined and the maximum payload length was extended to 64 bytes. Consequently all developed micro-controllers will switch to the most recent M\_CAN IP with 64 byte payload support.

The MCU family implements several M\_CAN instances depending on the micro-controller derivative. In short, each M\_CAN instance consists of a CAN

core, transmit and receive handler, generic master and slave interface and additional control and synchronization logic. While the generic master interface connects the M\_CAN to the external 32-bit message RAM, the connection to the host CPU is done by the generic slave interface.

### MCU's CAN sub-system

The CAN sub-system of the SPC57 devices includes several M\_CAN instances and a RAM controller as interface to the shared CAN RAM, which includes the transmit and receive buffers as well as the configurable CAN filter elements of each M\_CAN instance. The RAM controller consists of the SRAM interface, an active transmit message buffer protection, an ECC con-

troller and additional logic, which handles the arbitration of the RAM access requests by the M\_CAN instances and the CPU.

Each M\_CAN generic slave interface and the CAN RAM controller slave interface is connected to an individual slot on the 32-bit peripheral bridge while the M\_CAN generic master interfaces are connected to the CAN RAM controller. The shared CAN RAM array is organized by a 32-bit data and an 8-bit ECC. Each M\_CAN instance supports a maximum RAM-size of 1216 x 32-bit words (for M\_CAN including TTCAN 1344 x 32-bit words). The message RAM is used by the M\_CAN instance for storing of the 11-bit and 29-bit CAN message filters, two receive FIFOs, one receive buffer, one transmit event FIFO and one trans-

mit buffer. In case the time-triggered CAN communication feature of the M\_CAN IP is used, additional trigger RAM memory must be configured.

Each section of the message RAM is fully configurable in terms of the start address and the size. There is one exception regarding the transmit buffers. Those special sections of the CAN RAM are reserved and cannot be configured. Each element of those buffers can be protected by an M\_CAN hardware signal against CPU write access until the last valid data was transmitted. The maximum size supported by the M\_CAN is shown in Figure 3. The overall size of the message RAM module is assigned during the micro-controller derivative integration depending on the targeted application requirements. The flexible message RAM handling allows an optimized chip-size required by the CAN RAM, while the usage of this memory can be configured by the user according to the application requirements.

### CAN RAM bandwidth

For systems with multiple M\_CAN instances connected to one shared CAN RAM a consideration of the overall bandwidth requirements for the memory interface is mandatory. Any bottleneck in the data transmission has to be avoided in case all M\_CAN instances are running at high speeds and high message loads. On the other hand, oversizing of the system in terms of increasing the operating frequency should be avoided to limit the overall current consumption. An M\_CAN-specific theoretical worst-case data traffic to the shared CAN RAM is given by the following conditions:

- ◆ CAN FD mode
- ◆ 1 Mbit/s during arbitration
- ◆ 4 Mbit/s during payload transmission

	Configurable number of elements	32bit words per element	
11bit Message Filter	0...128	1	M_CAN up to 1216 x 32bit words
29bit Message Filter	0...64	2	
Rx FIFO0	0...64	4	
Rx FIFO1	0...64	4	
Rx Buffers	0...64	4	
Tx Event FIFO	0...32	2	
Tx Buffers	0...32	4	
TT-CAN Trigger Memory	0...64	2	
			M_TTCAN up to 1344 x 32bit words

Figure 3: Supported shared memory size by M\_CAN

Start Address Offset (byte)	End Address Offset (byte)	Size (Elements)	CAN Block/Sub Block	
SPC574K72				
0000 <sub>HEX</sub>	0CFF <sub>HEX</sub>	configurable by software	M_CAN 1	Standard Message Filters Extended Message Filters Rx FIFO0 Rx FIFO1 Rx Buffers Tx Event FIFO
0D00 <sub>HEX</sub>	0EFF <sub>HEX</sub>	32 (protected)		TxBuffers
0F00 <sub>HEX</sub>	18FF <sub>HEX</sub>	configurable by software	M_CAN 2	Standard Message Filters Extended Message Filters Rx FIFO0 Rx FIFO1 Rx Buffers Tx Event FIFO
1C00 <sub>HEX</sub>	1DFF <sub>HEX</sub>	32 (protected)		TxBuffers
1E00 <sub>HEX</sub>	2AFF <sub>HEX</sub>	configurable by software	M_TTCAN	Standard Message Filters Extended Message Filters Rx FIFO0 Rx FIFO1 Rx Buffers Tx Event FIFO
2800 <sub>HEX</sub>	2CFF <sub>HEX</sub>	32 (protected)		TxBuffers
2D00 <sub>HEX</sub>	2EFF <sub>HEX</sub>	32 (protected)		M_TTCAN triggers

Figure 4: Example of the shared CAN RAM as implemented in an SPC57 derivative





Figure 5: SPC5x micro-controller

- ◆ 128 active filter elements per CAN for an 11-bit CAN-ID
- ◆ 32 transmit buffers per M\_CAN
- ◆ DLC = 0
- ◆ 50-% CPU access time to the shared RAM

Assuming the mentioned conditions being applied to all M\_CAN implemented instances an internal RAM bandwidth of 15 Mbit/s for each module would be mandatory. A typical CAN subsystem consisting of three or four M\_CAN modules would require a clock frequency higher than accepted in terms of current consumption aspects. Based on the targeted powertrain applications the worst-case scenario can be changed by making the following assumptions:

- ◆ Maximum two M\_CAN instances running in CAN FD mode (1 Mbit/s arbitration and 4 Mbit/s payload)
- ◆ Up to three M\_CAN instances running in standard CAN mode (500 kbit/s or 1 Mbit/s)
- ◆ DLC  $\geq$  1

In this scenario the bandwidth requirements for the shared CAN RAM become less demanding and the CAN subsystem can be operated at 50 MHz, which is an appropriate frequency for automotive applications.

### CAN FD activities in automotive industry

The internal validation at STMicroelectronics of an 8-byte payload CAN FD controller has been started. The availability of the first silicon implementing CAN

FD is an important milestone to prove the CAN FD protocol controller on the target hardware.

The carmakers are very open-minded towards CAN FD and consider their internal evaluations as soon as the engineering samples will be available. Some of the carmakers go even beyond that and, already today, plans for the next generation networks supporting CAN FD are made.

The ECU suppliers currently focus on the reduction of the end-of-line programming time. Implementation of CAN FD as a faster backbone network has a lower priority. The semiconductor manufacturer is sustainably committed to automotive and will successively expand the SPC57 micro-controller family including CAN FD protocol controllers. Currently powertrain applications are targeted by the first developments. In parallel, micro-controller derivatives fulfilling the chassis and safety requirements are under development. The internal validation of a micro-controller derivative with a 64-byte-payload CAN FD controller is planned for Q4/2013. Slightly later delivery of engineering samples to strategic partners is planned.



### Control units from the ESX®-family



ESX®-3XL



ESX®-IOX



ESX®-TC3



- freely programmable controllers (in C and IEC61131-3)
- applications in mobile work machines and commercial vehicles

#### ESX®-3XL

32bit-controller with 136 I/Os, Approved for safety related applications (SIL2, PLd)

#### ESX®-TC3

Teleservice module with GSM, GPRS, GPS, Wi-Fi, Bluetooth®, Ethernet and USB

#### ESX®-IOX

CAN-Bus I/O-Modules

### Pressure transmitter with thin-film measuring element



- especially for applications in mobile machines and commercial vehicles
- highest media compatibility
- pressure ranges from 0 ... 25 bar to 0 ... 1000 bar (Overall accuracy in the temperature compensated range: 1%)
- max. media temperature 150°C / max. ambient temperature 125°C
- wetted parts and case in stainless-steel
- CAN-Bus interface

### Exhibitions



Hannover Messe, Hanover  
08. – 12.04.2012  
Hall 11, Booth F31



bauma 2013, Munich  
15. – 21.04.2013  
Hall A5, Booth 119

### Sensor-Technik Wiedemann GmbH

Am Bärenwald 6 · 87600 Kaufbeuren  
Germany  
Telephone +49 (0) 83 41-95 05-0

# Automotive and industrial use cases for CAN FD

Dr. Tobias Lorenz

## Author



Dr. Tobias Lorenz  
 Etas GmbH  
 PO Box 300220  
 DE-70442 Stuttgart  
 Tel.: +49-711-89661-0  
 Fax: +49-711-89661-107  
 tobias.lorenz@etas.com

## Link

[www.etas.com](http://www.etas.com)

## Introduction

In 1987 Bosch introduced the Controller Area Network, which soon became one of the most popular in-vehicle network technologies and was used in many other industries.

Today CAN is still the most commonly used network in the automotive area, but the latest vehicle systems with high data rates require the introduction of CAN FD (CAN with flexible data rate) as its successor.

The main advantage of CAN turned out to be a limiting factor for today's applications. Each CAN frame is acknowledged by the receiving nodes by sending an acknowledgment flag into the transmitted frame. Thus the sender gets a direct in-frame response on successful message transmission. However, this requires that the propagation time for sending the physical signal to the most distant node and back is not longer than the time frame for the acknowledgement signal itself. The propagation delay is mainly imposed by the transceivers and the cable length. Thus, there is a reciprocal relationship between the bit-rate and the propagation delay.

CAN was designed for a maximum bit-rate of 1 Mbit/s on a cable with a maximum length of 40 m. Due to the emission limits

and immunity tolerances, it is commonly used with lower bit-rates. In passenger cars it is used with a maximum bit-rate of up to 800 kbit/s, while 500 kbit/s is more common. Commercial vehicles have larger topologies, thus using up to 500 kbit/s, but it is more common to have 250 kbit/s. As applications become more and more bandwidth-intensive, CAN has to compete with more modern technologies such as Ethernet (bit-rates above 100 Mbit/s over a distance of 100 m). Beside the limited bit-rate, the maximum data field length of 8 bytes is also insufficient for today's applications. Transport protocols are necessary to transmit larger chunks of data.

With CAN FD it is possible to transmit a CAN frame with two different bit-rates. While the control data (arbitration, acknowledge-

ment) is sent with the nominal bit-rate, the data itself is transmitted with a higher bit-rate. The data bit-rate only depends on the transmission characteristics and capabilities of the physical layer, not on the signal propagation delay. This concept provides backward compatibility with existing CAN controllers. The second improvement is that a data frame can have up to 64 bytes of payload. In addition, the requirement for transport protocols can be dropped in several use cases. CAN FD also introduces the CRCs (cyclic redundancy checks) for larger frames, which take the CAN stuff bits into account. This ensures that the safety level remains constant with a hamming distance of six. Following are some of the use cases that directly benefit or even require CAN FD communication. ▶

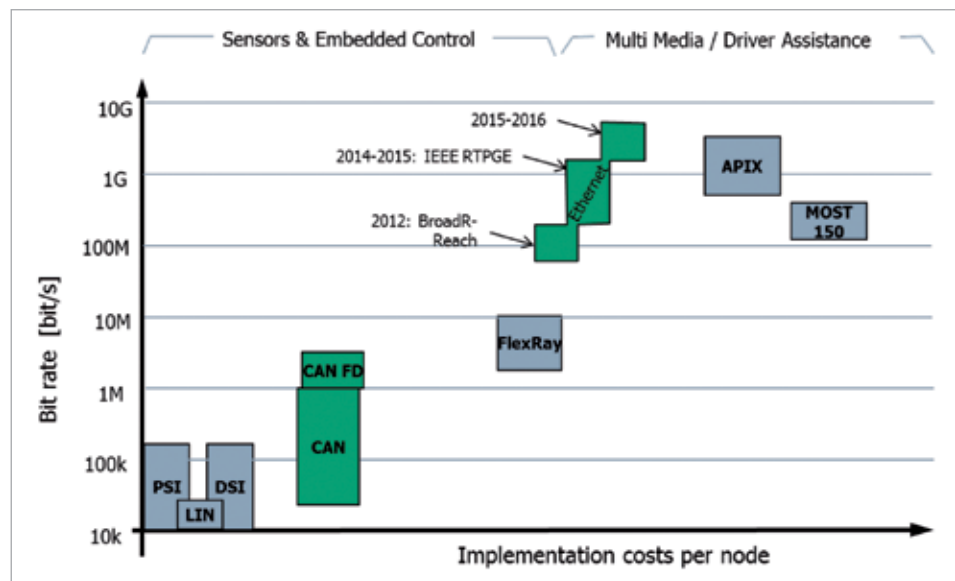

Figure 1: CAN FD provides a seamless upgrade path for CAN technology towards Flexray and Ethernet

en



PROEMION REAL-TIME →  
Fast and affordable telematics solutions





# PROEMION Real-Time →

## Worldwide access to operational and diagnostic data

### TRADITIONAL ON-SITE WORKSHOP DIAGNOSTICS



CAN data is read via cable connection – remote diagnosis is not possible.

### PROEMION REAL-TIME TELEDIAGNOSIS

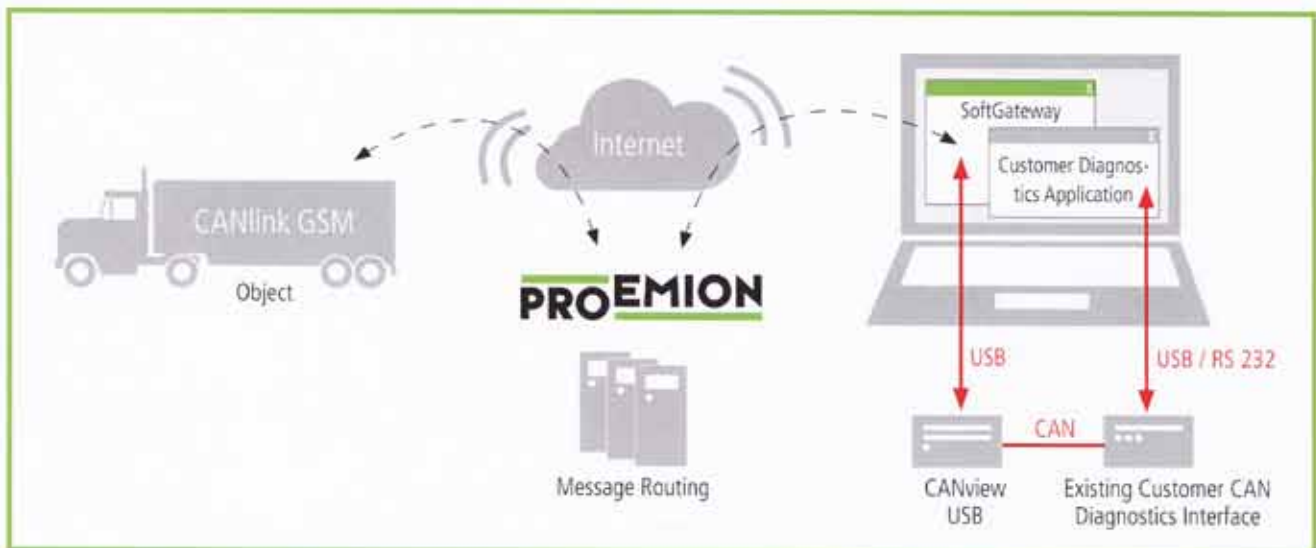

The PROEMION Real-Time remote diagnosis solution enables access to vehicle operational data, machines or remote objects in real time – anytime, anywhere. With conventional diagnostic systems, such data is only available on site. PROEMION Real-Time enables wireless connectivity with remote objects – regardless of distance. Global availability of diagnostic data not only facilitates error detection and prevention, but also allows a timely response to critical values. Errors can be rectified without costly and time-intensive on-site repairs, downtime is reduced or even avoided.

#### Advantages:

- > wireless access – thanks to GSM / UMTS bridging
- > immediate global diagnosis of vehicles and other remote objects
- > PROEMION Real-Time compliments / replaces workshop diagnostics
- > easy integration into existing hardware and software
- > extremely time- and resource-efficient
- > service-oriented solutions provide quick problem detection
- > effective diagnostics

# New Real-Time "Dashboard" feature →

A global telematics system – no additional hardware required

## NEW; PROEMION REAL-TIME "DASHBOARD"



As an advanced version of our established PROEMION Real-Time solution, "Dashboard" – a new desktop application – provides optimal, extremely user-friendly representation of globally retrievable CAN data. Upon installing the PROEMION CAN-link GSM / UMTS module no additional hardware modules are required for reading the accessed data.

PROEMION Real-Time can quickly process and clearly illustrate "Dashboard" data received via GSM / UMTS bridging. Results are individually configurable, no specific programming skills are required.

### Dashboard Software



Visualization individually configurable for:

- > cockpit instruments
- > circular displays
- > bar graphs
- > single to five-axis representation
- > value display
- > status indicator
- > buttons and switches
- > bar and line diagrams

The new "Dashboard":

- > is a free enhancement of PROEMION Real-Time
- > can be downloaded on [www.proemion.de](http://www.proemion.de) at the login area
- > is extremely easy to handle and price-oriented

Please review our range of services and let yourself be convinced by our diverse applications of telematics solutions.



# PROEMION Real-Time Package →

Our package includes the following components:



### CANlink™ GSM / UMTS

The CANlink transmits CAN messages to the PROEMION Real-Time Server via GPRS / UMTS and the Internet.

The device includes all required accessories and software, such as the SoftGateway.



### CANview™ USB (optional)

The CANview USB is connected to the PC's USB interface and converts all received messages to local CAN, so that the information transmitted to your existing CAN diagnostics device is equal to the source CAN messages.



### Security Token

The Token generates authentication data for on-line identification when accessing the vehicle or machine via a direct Real-Time connection.



### PROEMION Real-Time Server

The PROEMION Real-Time Server is for communication handling and message routing.



### SoftGateway

This software allows for authentication and connection establishment. Further, it receives CAN data from the PROEMION Real-Time Server and sends it to the local CAN via the CANview USB.



### New Dashboard Feature

The "Dashboard" desktop application displays data in real-time.

Cockpit instrument representation is individually configurable.

**PROEMION**  
Telematics Cloud

**DE** **PROEMION GMBH**  
**Headquarters**  
Donaustr. 14  
36043 Fulda, Germany  
Phone +49 661 9490-600  
Fax +49 661 9490-666  
info@proemion.com  
www.proemion.com

**US** **PROEMION CORP.**  
**US Subsidiary**  
711 E. Monument Ave., Suite 310  
Dayton, Ohio 45402-1490, USA  
Phone +1 937 558-2211  
Fax +1 937 641-8787  
Toll-Free +1 877 RMCAN-US  
info@proemion.com  
www.proemion.com



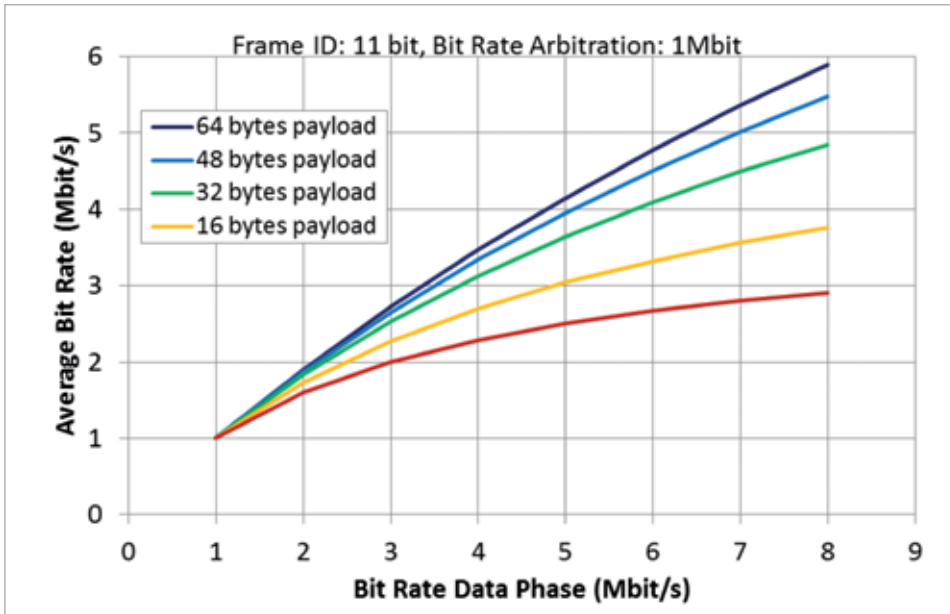

Figure 2: The average CAN FD bit-rate benefits from payloads of up to 64 bytes

### Fast software download

According to Moore's Law, the complexity of integrated circuits doubles every 12 months. As stated by Intel executive David House, the performance doubles in a period of 18 months. Similar numbers apply for the overall system complexity and software size. This has already led to the problem that complete software downloads via the on-board diagnostic (OBDII) port to the vehicle ECUs take several hours.

According to General Motors [3] (similar numbers apply for other OEMs as well), the CAN-based OBDII port is used with a nominal bit-rate of 500 kbit/s. To have the maximum net bit-rate, transmissions are supposed to have 8 bytes of data. Thus the time to transmit each frame is 1021  $\mu$ s.

With CAN FD, the nominal bit-rate is kept at 500 kbit/s, but a data bit-rate of 2 Mbit/s is used. In addition, frames are transmitted with 32 bytes of payload. Increased bit-rate and payload length leads to a reduction in transmission time to 229  $\mu$ s (see Figure 3). Thus, a four times higher net bandwidth can be achieved solely on the pro-

ocol layer. Further speed increases are gained due to the reduced overhead of the transport protocol. A transport protocol usually requires 1 byte for PID (Packet ID), and the 7 bytes of DAQ (data acquisition message), thus resulting in an 88-% net rate. With CAN FD, up to 63-bytes DAQs

are possible, which results in a 98-% net rate.

### Time-synchronous data transmission for one motion controller

Real-time applications require a reliable time behavior. Mapped to network

	CAN	CAN FD
Bitrate	Nominal: 500 kBit/s	Nominal: 500 kBit/s Data (FD): 2 MBit/s
CAN payload	8 Byte (~15% stuff bits)	32 Byte (~15% stuff bits)
Time to transmit	1021 $\mu$ s	229 $\mu$ s

Figure 3: With CAN FD about four times higher net bandwidth is realistic

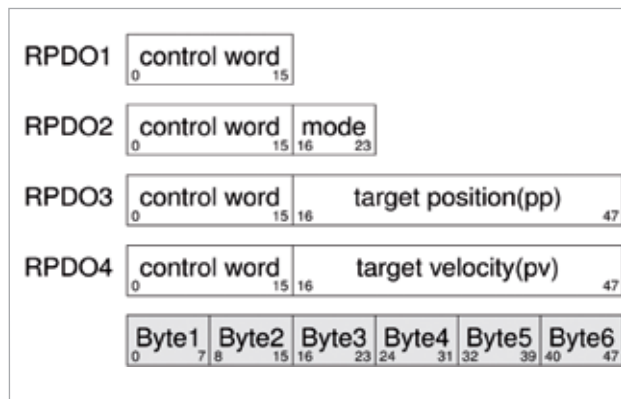

Figure 4: Four PDOs are required to position a motion controller with classic CAN

### Tools for CAN FD

Etas already provides tools for CAN FD. During the CAN FD Tech Day in Detroit, modified versions of the FPGA-based ES593-D device and Busmaster were presented. The ES593-D is a member of the CAN FD-capable ES59x ECU and bus access module series also including ES592 and ES595. The ES910 rapid prototyping module supports CAN FD as well. The scalable ES8xx system with a power plate on the bottom and several modules stacked on the top, is scheduled for release in Q2/2014. The available modules interconnected via a high-speed communication network with low latency will include the ES850 analog input module, the ES820 computing module, and the ES890 ECU and bus interface module. The latter will feature CAN, CAN FD, Flexray, ECU access, and connectivity to other company's legacy hardware.

Busmaster 1.7.0 free-to-use open-source solution for network analysis and simulation supports CAN FD. It handles the second bit-rate and frames with up to 64 bytes, each in the message window, and the node simulation. The tool is available since November 2012 and can be downloaded at <http://rbei-etas.github.com/busmaster>. Inca is a CAN FD-capable tool for measurement, calibration, and diagnostics. The support will be officially released with the market introduction of the ES890. As of today, the configuration formats and transport protocols are not yet ready for CAN FD. Further standardization in ASAM, ISO, and SAE is necessary to take full advantage of CAN FD.

## References

- [1] Vector Congress, November 2012, Stuttgart, Germany, CAN FD – CAN with flexible data rate, Thomas Lindenkrenz, Robert Bosch
- [2] CAN FD Tech Day in Detroit, USA, October 2012, CAN FD – CAN with flexible data rate, Florian Hartwich, Robert Bosch
- [3] CAN FD Tech Day in Detroit, USA, October 2012, CAN FD requirements from the OEM point of view, Natalie Wienckowski, General Motors
- [4] International CAN Conference in Hambach Castle, Germany, March 2012, Using CAN with flexible data rate in CANopen systems, Heinz-Jürgen Oertel, Port
- [5] CAN FD Tech Day in Detroit, USA, October 2012, Safe-guarding of CAN FD for applications in trucks, Marc Schreiner, Daimler AG

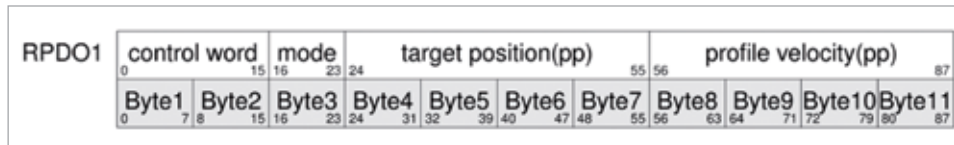

Figure 5: With CAN FD, one message is sufficient to position a motion controller

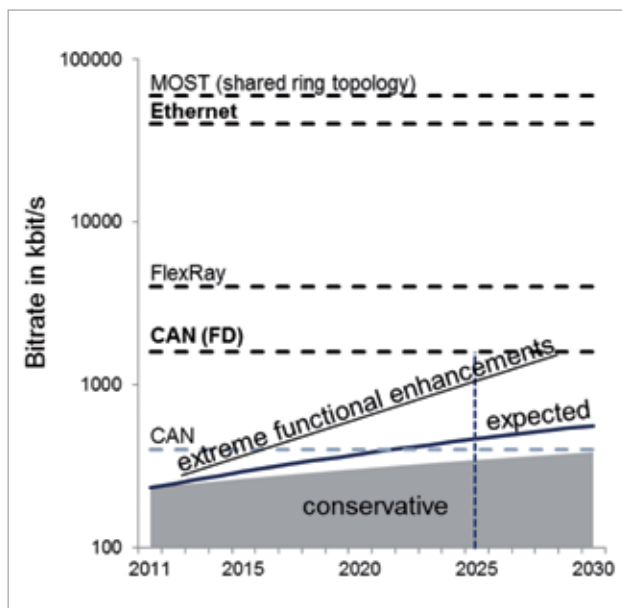

Figure 6: Bit-rate requirements growth estimation for electrical vehicles

technologies, this requirement results in a time-synchronous transmission of information. Due to the fact that CAN is limited to a data field size of 8 bytes, more information has to be transmitted in subsequent messages. To have a reliable time behavior, it has to be ensured that there is no delay or interruption of the transmission due to frames with higher priority. An example for such application is a robot arm [4]. Each axle in this arm is equipped with a motion controller implementing the CANopen device profile for drives and motion control (CiA 402). For each motion controller (axle) four PDOs (process data objects) have to be transmitted with a total of 23 bytes (see Figure 4 in [4]). With the increased CAN FD data field size, there is only one CAN FD frame necessary to position one motion controller. Without further measures, a time-synchronous transmission of information is ensured. In addition, the total number of bytes

required for the complete transmission is reduced to 11 bytes, which is a 50% increase in efficiency.

### Higher bandwidth for electric vehicles

Among the CAN-based systems in a vehicle, the powertrain CAN has the highest average utilization. This is mainly due to the communication between the motor control unit and the transmission control unit. Commonly it is used with 500 kbit/s and has a utilization of 50 %.

Especially when it comes to electric/hybrid vehicles, new powertrain concepts demand a much higher bit-rate and utilization. Motor control unit and transmission control unit will be replaced by a vehicle control unit, DC/DC inverter control unit, battery control unit, charger control unit, and range extender control unit. Estimations show that by 2025, the expected required bit-rate will exceed the abilities of CAN and require at least CAN FD (see

Figure 6 in [1]). Thus CAN FD is fit for the next generation of powertrain requirements.

Let's assume all frames are transmitted with 8 bytes. Due to the control information in the frame header and trailer, and the additional stuff bits, the data consumes between 40 % and 58 % of the total frame. Using CAN FD and data frames with 32 bytes, the efficiency can be improved to between 64 % and 84 %. In addition, if the nominal bit-rate stays at 500 kbit/s, and a data bit-rate of 4 Mbit/s is introduced, the combined average bit-rate is approximately 1,41 Mbit/s. Both actions result in a reduction of network utilization from 50 % to 11 %. There is no need to add further CAN networks to handle the utilization problem, but further ECUs can be added to existing CAN networks.

### Accelerated communication on long CAN lines

Articulated busses feature a CAN network with a length of approximately 20 m. Trucks have a frame length of approximately 9 m. The electronics architecture of trucks and busses is standardized in the SAE J1939 specification. Part 11 and 14 both define the physical layers with a bit-rate of 250 kbit/s and a maximum bus length of 40 m. In the last years, several systems e.g. such ADAS systems (advanced driver assistance systems) as lane departure warning, bird-eye view, and brake assist, migrated from the passenger car segment into the truck and trailer market. This trend demands higher bandwidth than J1939 offers today. J1939-14 was

# CANopen® Products and Services

	SAE J1939-11	SAE J1939-15	SAE J1939-14
Issued	2006-09	2008-08	2011-10
Bit rate	250 kBit/s	250 kBit/s	500 kBit/s
Bus length (L)	40 m	40 m	56.4 m
Stub length (S)	1 m	3 m	1.67 m
Nodes (n)	10	30	30

Figure 7: The nominal bit-rate of J1939 is 250 kbit/s. The introduction of CAN FD with a 4-Mbit/s data bit-rate would lead to an average bit-rate of 810 kbit/s.



Figure 8: The ES59x and ES9xx series are prepared for CAN FD

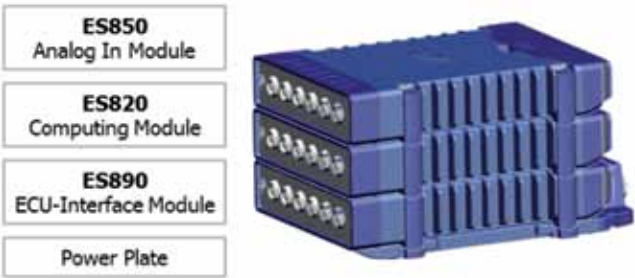
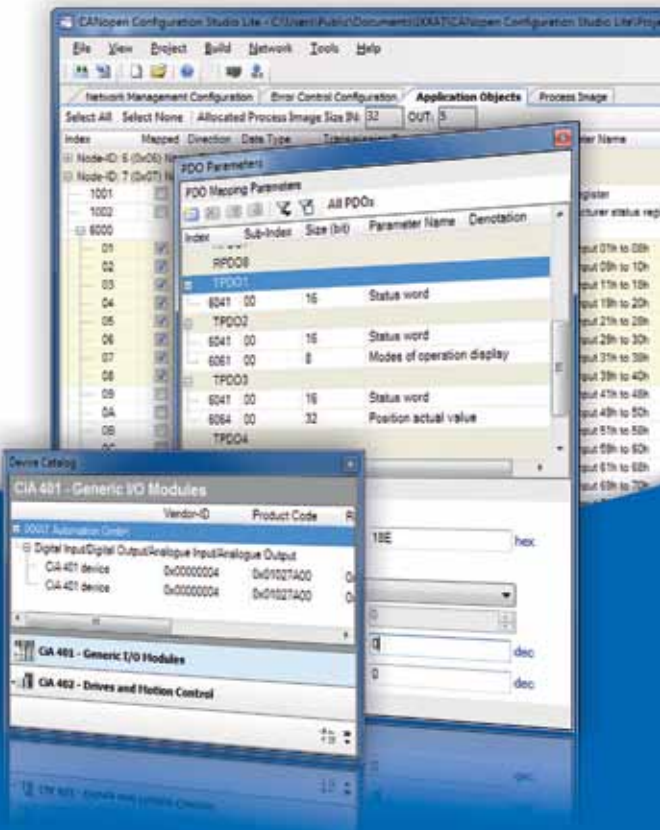

Figure 9: ES8xx series with the ES890 ECU and bus interface module

standardized to have a bit-rate of 500 kbit/s and increased the maximum bus length to 56,4 m. With CAN FD it is possible to keep the nominal bit-rate constant, and to increase the data bit-rate independent of the cable length. If CAN FD is used with a nominal bit-rate of 250 kbit/s and a data

bit-rate of 4 Mbit/s, the average combined bit-rate would be 810 kbit/s. Thus, the transfer capacity is increased to 324 %.



- ▶ CANopen® Master/Slave protocol software for the development of embedded applications
- ▶ Windows CANopen drivers enable quick implementation of PC-based control and test applications
- ▶ Broad range of PC interfaces to fit your specific requirements
- ▶ Tools for configuration, testing and analyzing
- ▶ Consultation, implementation and development services



# Control panel solution for printing machines

## Companies

**Biviator AG**  
Tannackerweg 4  
CH-2572 Mörigen  
Tel.: +41-32-39707-80  
Fax: +41 32 39707-81  
info@biviator.ch

**Lüscher AG**  
Maschinenbau  
Bodenackerstr. 7  
CH-5014 Gretzenbach  
Tel.: +41-62-76776-77  
Fax: +41-62-76776-76  
mailbox@luescher.com

## Links

www.biviator.ch  
www.luescher.com

**PLC manufacturer**  
Biviator Industrie-elektronik is an engineering office and a controller manufacturer. Coming from the watch industry, the company has 50 years of experience in automation, development, production and testing of the industrial electronics.

**Machine builder**  
The 65-years Lüscher Maschinenbau is specialized in development and manufacturing of mechanics and electronics for CTP (computer-to-plate) systems used in offset, flexographic, letterpress and screen printing processes. The portfolio includes computer-to-plate systems and automation solutions for job, packaging, industrial and security printing.



Figure 1: The 96-pages roll offset machine Lithoman S with a sheet width of 2,86 m

Biviator and Lüscher Maschinenbau jointly developed the Codesys-programmable Chimaera PLC (programmable logic controller) and HMI (human machine interface) for the Lithoman S offset printing machine. While the engineering process, the PLC was extended by a second CAN communication circle. Additionally, a pixel-clock card with a fiber optics interface was included into the controller's housing.

From the basic idea to have a cost-effective PLC and HMI solution in one device, the Chimaera Lu750 controller was developed, which is a version of Biviator's customizable Chimaera Embsys adapted to the machine manufacturer's requirements. The system features a 100-Mbit Ethernet interface, a file system and two USB host ports for connection to the PC world. For communication in the

field two CANopen NMT master channels are provided. Programming of the system is fulfilled using the Codesys v. 3 development environment, which offers object-oriented programming, internal visualization and version management possibility. Further, diverse interfaces, GPIOs (general-purpose I/Os) and an FPGA (field-programmable gate array) are available. The latter allows hardware-programming in VHDL (a hardware description language for integrated circuits).

The machine may be operated via the controller's touch-screen as well as via a web-based visualizing tool. The functionality of the latter was extended to provide a support tool, using which a service technician from Lüscher may operate and maintain the machine on-site or via Internet from any connected PC.



Figure 2: Chimaera Lu750 embedded system board



Figure 3: Chimaera Lu750 control panel built in a housing

# Flexible IO Modules

## The Chimaera embedded system

### Hardware

- Central unit (module): Nvidia Cortex-A9 MP-Core, Tegra2 2 x 1-GHz (option), Marvell ARM Xscale, PXA320 (806 MHz) CPU
- Memory: DDR RAM up to 512 MiB, Flash up to 1 GiB, MicroSD card
- Interfaces: 2 CAN, Ethernet (100 Mbit/s), 2 USB (Host), RGB, DVI, HDMI (option), resistive touch, audio, 3 serial COM (option), 2 SPI, I2C, One Wire, address/data bus (option)
- Periphery: Digital I/Os, Analog I/Os, PWM, hardware-timer, IRQs, FPGA (co-processor, IP cores), power fail, watch dog and RTC
- Displays: 5,7-inch to 15-inch touch display (option)
- Power supply: Input 24 V; output 1,2 V, 2,5 V, 3,3 V and 5 V

### Software

- Operating systems: Windows CE 5, 6, 7, Linux, Android (option)
- Programming: C, C++, C#. Codesys v. 3, Silverlight, VHDL
- Server: HTTP, FTP, Telnet, file server (SMB), mail server; Codesys: OPC server, web server
- Protocols: HTTP, FTP, TCP, UDP, SMB, Telnet; Codesys: CANopen, ModbusTCP
- Database: MySQL
- Tools: Remote display und BivTools
- Visualizing: Codesys: Web, HMI, target visualizing

The documentation, programs and further files may be stored directly on the PLC by means of the included file system or on a server via a network access. Thus, a back-up image of the system's software may be created, downloaded and uploaded.

### Printing facility

The printing facility consists of a plate handling system (PHS) and an imaging system. The PHS for the roll offset machine Lithoman S incorporates two plate magazines, which handle up to ten different plate formats. From there, the plates are inserted in one of the two imaging systems via a plate pickup drum. After imaging the plate is handed over for further processing via a second internal drum. The introduced PLC handles the control of the PHS and the imaging system. Thanks to customer-specific hardware (e.g. pixel-clock card inter-

face, individual housing and form) and software (e.g. customized software image) adaptation a copy protection of the PLC is given.

The different variants of the PLC were built into the facility by stages. First, the plate handling system was equipped with the Lu750 control panel with HMI and PLC functions. Next, the control panel exchanged the previously used operator panel for the imaging system. Finally, the Lu750 was included into the imaging system. In addition, a further facility was equipped with a low-cost variant of the control panel.

Due to the modular concept and availability of diverse interfaces, the control system may be extended in the future, if further requirements are given. The device may also be used in other kinds of machines e.g. for punching, water treatment, watch or textile industries. ◀

EtherCAT<sup>®</sup>  CANopen



- ▶ Quick and cost effective connection of analog and digital IO signals
- ▶ Up to 16 digital and analog (12 bit resolution) inputs and outputs, depending on device version
- ▶ For CAN, CANopen and EtherCAT
- ▶ Ready to use pre-configured devices; optional easy configuration via free tools or system controller
- ▶ Rugged design for industrial and automotive usage

OEM



The IXXAT IO Modules are also available as board level product or customized OEM design for easy integration into customer products

**IXXAT**  
Your Partner for Communication

IXXAT Automation GmbH  
Leibnizstr. 15 · 88250 Weingarten  
Tel.: +49-(0)7 51 / 5 61 46-0  
Internet: www.ixxat.de

# CANopen Safety with Codesys Safety for SIL 2

Roland Wagner, Ingo Hornberger

## Authors

Roland Wagner  
Ingo Hornberger

3S-Smart Software  
Solutions GmbH  
Memminger Str. 151  
DE-87439 Kempten  
r.wagner@codesys.com

## Link

[www.codesys.com](http://www.codesys.com)



The CANopen Safety protocol developed by CAN in Automation (CiA), international users' and manufacturers group, was published in 2010 as a European standard EN 50325-5. The protocol allows for safety-relevant data transmission via CAN networks according to the IEC 61508 standard. The German TÜV Rheinland has approved the protocol for use in systems requiring Safety Integrity Level 3 (SIL 3).

With Codesys Safety SIL2 from 3S-Smart Software Solutions, the first integration of the CANopen Safety protocol into an IEC-61131-3 development environment is available. The software tool consists of two parts. These are the Codesys Control runtime system certified according to the IEC 61508 and the Codesys Development System, which is an IEC-61131-3 programming system.

Using the tool the development and integration of the safety-relevant applications into the existing CANopen-based controller networks is possible. This combination is well suited for mobile machines e.g. in the construction industry where Codesys is already broadly applied in control systems.

Implementing CANopen Safety functionality based on Codesys Safety SIL2 allows integration of a number of already certified I/O devices from diverse manufacturers into customer's functionally-safe machine.

The CANopen Safety protocol stack was developed in accordance to the EN 50325-5 standard. It is based on the company's CANopen stack, which offers the CANopen NMT (network management) slave functionality (compliant with the CiA 301 specification) for communication with other CANopen devices in the network. With regard to the architecture, the CANopen Safety stack is attached on top of the standard CANopen stack and uses the latter to

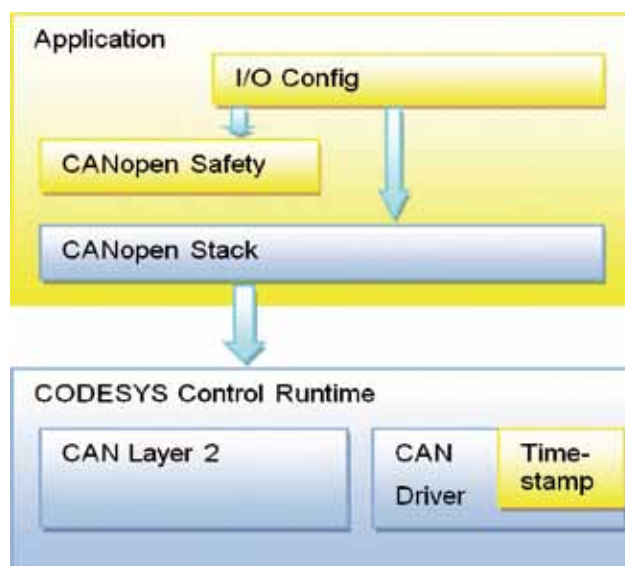

Figure 1: Architecture of the Codesys CANopen Safety stack



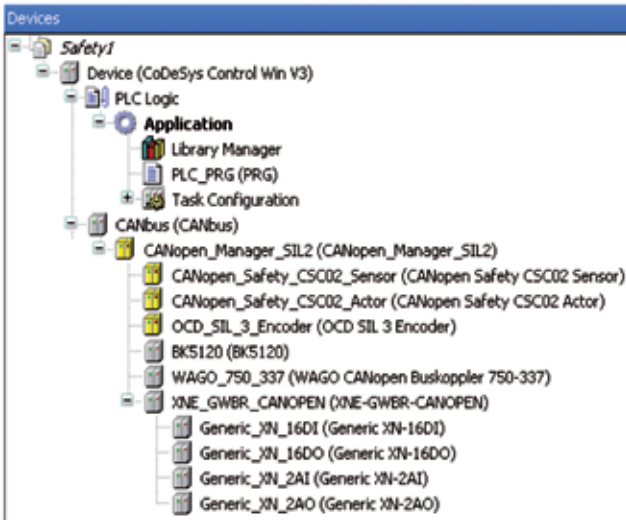

Figure 2: Mixed usage of standard and safety-relevant CANopen NMT slaves in a Codesys project

receive and to transmit PDOs (process data objects). The implementation of the CANopen Safety stack is independent from the hardware, which means that it can be used

with potentially any available CAN chip. For connection, a miniature CAN driver is required, which is already available for most of the CAN chips. For realization of a safety-

relevant solution, the complete CAN communication channel is regarded as not safe. The CANopen Safety stack handles all possible failure scenarios. The only safe software parts are the CANopen Safety stack and a small part of the CAN driver.

By means of this TÜV-certified solution it is possible to use safety-relevant CANopen devices and standard CANopen NMT slaves in the same network. Compliance with both kinds of CANopen devices was considered in the development phase.

As the first manufacturer, Sensor-Technik Wiedemann (Germany) ported the Codesys Safety SIL2 to one of its mobile controllers. Starting from fall 2013, the ESX-3XL will be available on the

market with the implemented Codesys CANopen Safety stack. Already in summer 2013, the controller will be available with a proprietary CANopen Safety solution. We will show the controller solution at the Bauma 2013 trade fair in Munich on the joint-stand from CAN in Automation (CiA).



The Moba Operand is programmable with the Codesys software and provides CANopen connectivity

Codesys, the IEC 61131-3 compliant runtime system, has been used in very different applications. Besides typical industrial machine control systems and in factory automation, it has also been implemented in mobile machines and other unusual applications including train control systems.

A typical application is the photovoltaic solar-panel production line that uses automation equipment by Berghof (Germany). The EC1000 programmable logic controller (PLC) running Codesys controls the RStep motion controllers via CANopen. It also communicates via Ethercat with the ET1000 human machine interfaces (HMI), which also features the Codesys runtime and program-

## Soft-PLC in applications

ming system. The stepper motors are configurable by means of the Codesys motion function block library.

Another example is the Chimæra Lu750 PLC with integrated HMI functionality jointly developed by Biavator and Lüscher (both Switzerland). The IPC (industrial personal computer) is programmable using the Codesys environment. It controls Lüscher's CTP (computer to plate) devices used in modern printing processes. The panel controller manufactured by Biavator provides CANopen connectivity.

Sigloch (Germany) specialized in machines for binding books and brochures use the XC200 controller by Eaton (Germany) featuring Codesys. The PLC's CANopen interface is used to connect drives and other peripherals.

In mobile automation, Moba (Germany) uses Codesys, for example, for its MDS-2000 drilling system, its HBM MPC-210 grader control systems, and its software for aerial work platforms. Janz Tec (Germany) has implemented Codesys in its CANopen-connectable PC-based controllers, which are applied in the Tourmix mobile feed mixing plant by

Buschhoff (Germany) and in the aircraft tractor by Trepel (Germany).

In order to give customers access to ready-made solutions, 3S-Smart Software Solutions (Germany) has opened the Codesys store on the Internet. The products offered include free-of-charge sample projects, device description files, utilities, tested application libraries, additional visualization elements, and tool plug-ins. Beside the products offered directly by 3S, the store also offers third-party products from device manufacturers, system partners or other independent providers. From Codesys V3.5 ServicePack 2 on, the store will also be integrated in the Codesys programming system. This enables users to look for suitable software add-ons when working in the IEC 61131-3 tool. All selected packages can be installed, licensed and rated directly in Codesys, without intermediate storage. Moreover, users will be informed about available updates for installed software add-ons. Unfortunately, there is up to now no CANopen additional function available in the store.

Holger Zeltwanger

<http://store.codesys.com>

# Experimental CANopen EEC management

Dr. Heikki Saha

## Author

Dr. Heikki Saha  
sahat@kotiposti.net

## Introduction

This article shows how CANopen EECs (emergency error codes) can be described in EDS (electronic data sheet) and DCF (device configuration file) files and how EEC abstractions can be generated automatically for IEC 61131-3 programmable devices from a CANopen project.

This work should also help defining the EEC decoding information into XML-format XDD and XDC files, which will replace the current EDS and DCF files and provide some enhancements.

Current CANopen design files do not support EECs (emergency error codes) with their human readable descriptions. This feature has become more problematic because of abstraction to parameters and signals. The system structure has become automated and proven way of working [6] [7]. Manual EEC management is decreasing the development efficiency because it is time-consuming and prone to inconsistent codes. These design projects are iterative and effort is wasted on each cycle of each project by managing EECs manually. Descriptions shall be uniformly defined for both producers and consumers.

This article shows how CANopen EECs (emergency error codes) can be described in EDS (electronic data sheet) and DCF (device configuration file) files and how EEC abstractions can be generated automatically for IEC 61131-3 programmable devices from a CANopen project. CANopen design files contain device version information that enables to manage version-specific EECs. Codes are defined as global constants for emergency (EMCY) producers and a decoding function is generated for EMCY consumers. Centralized management enables definition of each code once in the producer's EDS file and unlimited reuse of the codes.

The work made for this article is communicated to CiA TF (task force) XML to help defining the

EEC decoding information into XML format XDD and XDC files [2], which will replace the current EDS and DCF files and provide some enhancements. Due to the standardized CANopen interfaces [3], EEC management is demonstrated with devices programmable in IEC 61131-3 structured text (ST), but programming language is not limited to it.

## Source information

CANopen project is the source of information for all system integration information, including error codes with multilingual descriptions. Nodelist.cpj list the DCF files of each device in a project. Widely supported DCF and node list files are used in the experiments to enable the evaluation of EEC management in existing projects, where tool integration is used.

Standard entries exist for target position specific-information. Node-ID of each device is required in decoding because EECs with overlapping descriptions are not systematically prevented by CAN in Automation (CiA). Network-Name is used as a part of the export file name to support devices with multiple

CANopen interfaces. Net-Number is future reservation for remote EMCY decoding. An excerpt from a DCF file containing Device-Commissioning section is presented in Figure 1.

Experimental entries defining emergency error codes have been added to current EDS and DCF files to enable to prove the concept in real projects [1]. Multiple languages can be supported for code descriptions. Same language codes with XDD and XDC are supported [2] [4] [5]. The experimental extensions presented in Figure 2, are proposed as a part of the future XDD and XDC files [2].

Entries NrOfLang and LangN can be used in determining the languages supported by EDS or DCF file. CodeN is a key for each EEC. Missing descriptions can be determined, when the language is supported for e.g. description in en-usN for code CodeN is missing. Number of supported codes is defined in NrOfCode. Entry LabelN is used as a name of a generated EEC constant for application-programmable EMCY producer. A short label needs to be entered manually because automatic name generation

```
01 [DeviceComissioning]
02 NodeID=3
03 NodeName=FCN_SEL
04 NetNumber=1
05 NetworkName=HIT_MAIN
06 Baudrate=1000
07 RefDesignator=Y1003
```

Figure 1: Example device commissioning section of a DCF file

```

01 [EmcyDecode]
02 NrOfLang=2
03 Lang1=en-us
04 Lang2=fi
05 NrOfCode=7
06 Code1=0x0000
07 Label1=NoErr
08 en-us1=No error(s)
09 fi1=Ei virheita
10 Code2=0x5003
11 Label2=FlashErr
12 en-us2=FLASH storage error
13 fi2=FLASH muistin tallennusvirhe
14 Code3=0x6120
15 Label3=CoDevEvt
16 en-us3=CANopen device event
17 fi3=CANopen laitteen tapahtuma
18 Code4=0x6122
19 Label4=CoMgrEvt
20 en-us4=CANopen manager event
21 fi4=CANopen isannan tapahtuma
: :

```

Figure 2: Example EEC description section for EDS and DCF files

from description may result in ambiguous constant names. Comparable additional short labels are also defined in object attribute Denotation for remotely accessed parameters [7].

### Producer abstraction

Abstraction for EMCY producer is just a section of global constants, which is included in the same export with local parameter and signal abstractions [7]. Constant definitions are located under section Global\_EEC\_<NetworkName>. Naming convention <NetworkName>\_<LabelIN> is used for constant names to support unique names for multiple network interfaces of a device. Constants can be used directly as EEC inputs for EMCY producer function block [3]. Short la-

belts are needed because network name is added to the constant names and because of limited number of significant characters in variable names. Source file and conversion time are included as a comment line. An example abstraction for EMCY producer is shown in Figure 3.

### Collecting information

This section describes the phases of the error code and description collection process. The program structure is designed to enable further support of next generation XML format input [2] and output files [8] and integration into part of existing export tool [7].

Project file type is detected first. In addition to the standard nodelist.cpj

project file, also a tool-specific nodelist.pco is supported. The automatic detection function first tries to access the standard file and if it is not found, it tries to read the proprietary file. It is assumed that the project files are located in the same folder with the DCF files of the project.

Project file parse functions are implemented in both supported formats. Those functions read the paths of the project's DCF files. Nodelist.cpj lists DCF names without path and project path is added by the parse function. Absolute project path is used for DCFs in nodelist.pco and those paths are replaced with current project path to avoid a need for additional changes if project files are moved from one folder to another.

Information of nodes is read next. The values of standard entries Node-ID and NetworkName are used for producer identification. The experimental section is used for code to description mapping in specified language. Collection supports multiple languages and warnings are generated if the specified language is not supported or if a missing description is found for a code.

Information filtering and sorting follows parsing. If there are different descriptions for the same code used by different nodes, several decoding lists will be used. Filter function combines the non-over-

### References

- [1] CANopen electronic datasheet specification – Part 1: General definitions and electronic data sheet specification, CiA 306-1, CAN in Automation
- [2] CANopen device description, XML schema definition, CiA 311, CAN in Automation
- [3] Accessing CANopen services in devices programmable in IEC 61131-3 languages, CiA 314, CAN in Automation
- [4] Codes for representation of names of languages – Part 1: Alpha-2 code, ISO 639-1:2002
- [5] Codes for the representation of names of countries and their subdivisions – Part 1: Country codes, ISO 3166-1
- [6] Saha H., Wikman M., Nylund P., CANopen network design and IEC 61131-3 software design, CAN Newsletter 3/2009, 2009, pp. 52-58
- [7] Saha H., Improving development efficiency and quality of distributed IEC 61131-3 applications with CANopen system design, Proceedings of the 13th iCC, 2012, pp. 10-15 – 10-21
- [8] XML formats for IEC 61131-3, version 2.01 – Official release, Technical paper, PLCopen Technical Committee 6, 2009, 80 p.

```

01 (* @GLOBAL_VARIABLE_LIST := Global_EEC_HIT_MAIN *)
02 (* @PATH := '' *)
03 VAR_GLOBAL CONSTANT
04 (* EMCY error codes 05.11.2012 18:23:42 from D002.DCF *)
05 HIT_MAIN_NoErr: WORD := 16#0000;
06 HIT_MAIN_FlashErr: WORD := 16#5003;
07 HIT_MAIN_CoDevEvt: WORD := 16#6120;
08 HIT_MAIN_CoMgrEvt: WORD := 16#6122;
09 HIT_MAIN_SeqExc: WORD := 16#6201;
10 HIT_MAIN_LowVBat: WORD := 16#6220;
11 HIT_MAIN_NormVBat: WORD := 16#6221;
12 END_VAR
13 (* EOF *)
14 (* @OBJECT_END := Global_EEC_HIT_MAIN *)

```

Figure 3: Example EEC abstraction for EMCY producer as Codesys 2.x export format



```

01 C:\>python dcf2emcy.py "C:\..\dcf" en-us
02
03 Selected output language is: en-us
04
05 EMCY decoding for network: HIT_MAIN
06
07 Group 0: 28 codes for 13 nodes
08 Group 1: 16 codes for 2 nodes
09
10 C:\>

```

Figure 4: Example console screenshot of generating EEC decoding function for EMCY consumer

lapping code – description value pairs and separates overlapping information into separate lists. If a second node introduces overlapping codes, all of its codes are stored into another decoding list.

Codes are sorted before exporting the decoding function. Ascending order of the EECs is used. Sorting may not be mandatory, but sorted codes in the decoding function help reading and possible troubleshooting.

Decoding function is generated in Codesys 2.x export file format as a last phase. Current output format is presented in details in section “error code decoding” of this article. The file output function is isolated so that PLCopen XML information transfer format [8] support may be added later on as an option.

## Executing the generator

Figure 4 presents an example of typical execution of the generator with required command-line options. First option indicates the path of the CANopen project – a folder, where either nodelist.cpj or nodelist.pco exists. Language selection for decoded code descriptions is selected by the second option. Supported language codes are adopted from XDD and XDC specification. Due to the DCF path replacement, dcf2emcy.py can read any CANopen project after folder changes and without any modifications to the project files.

Typically dcf2emcy.py is called from make-procedure or comparable batch execution mechanism of a project. Lines 7 to 8 indicate that two decoding lists were generated because of overlapping EECs. Output files are named as <NetworkName>\_<Language>.exp to enable the export of multiple language packets in the same batch. Target file example in Figure 5 is HIT\_MAIN\_en-us.exp resulting from the conversion presented in Figure 4.

## Error code decoding

Error codes are decoded by a simple function. The ex-

ample in Figure 5 presents how EECs produced by different node groups can be decoded differently. Inside the CASE-clauses, codes are sorted into ascending order based on the code values. EECs that are unknown or from undefined nodes are shown just as a raw decimal code values. Comment in line 1 indicates that the function is imported under NMT master group of project program organization units (POU). Comment in line 10 documents, from which file and when the information is exported. There is network-ID included at the end of the comment line to enable combining multiple decoding functions in the future.

Decoding function takes two arguments declared in lines 4 to 5 – producer node-ID and EEC of an event. CASE structures are used to keep the implementation simple. First, list size in bytes is limited in the PLCs, which would introduce problematic limits with list of visible strings. Second, code value range is

large and only some codes are used – with lists, most of the items were unused but still reserving memory space.

Two levels are required, because different devices can use same codes differently. The outer CASE structure determines, which decoding list is used and for which nodes. The inner CASE structures in lines 13 to 44 and 46 to 65 decode the given EECs into corresponding descriptions. Due to the memory constraints of target device category, language selection is made during the design time, before compilation. For other kind of targets, run-time language selection may be used by e.g. adding one CASE level more for language selection.

Example event list utilizing an exported decoding list is presented in Figure 6. The example has been implemented in IEC 61131-3 programmable display. Event information is retrieved directly from standard CANopen EMCY consumer. Producer node

```

01 (* @PATH := '\NMT master' *)
02 FUNCTION GetEeCode : STRING
03 VAR_INPUT
04   NId: BYTE;
05   EEC: WORD;
06 END_VAR
07 VAR
08 END_VAR
09
10 (* Generated at Sat Oct 27 20:32:13 2012 for network HIT_MAIN (1) *)
11 CASE NId OF
12 2, 3, 4, 5, 6, 7, 8, 9, 10, 11, 12, 13, 17:
13   CASE Eec OF:
14     16#0000: GetEeCode := 'No error(s)';
15     :
16     16#F000: GetEeCode := 'Additional functions';
17   ELSE
18     GetEeCode := WORD_TO_STRING(EEC);
19   END_CASE;
20 18, 19:
21   CASE Eec OF
22     16#0000: GetEeCode := 'No error(s)';
23     :
24     16#FF01: GetEeCode := 'Inline status';
25   ELSE
26     GetEeCode := WORD_TO_STRING(EEC);
27   END_CASE;
28 ELSE
29   GetEeCode := WORD_TO_STRING(EEC);
30 END_CASE;
31 (* EOF *)
32 END_FUNCTION

```

Figure 5: Example device commissioning section of a DCF file



Figure 6: Example screenshot of event list with decoded codes in en-us

names are retrieved from information exported for heartbeat consumer.

### Results and outlook

When EEC decoding information is described already in EDS files, significant time saving is achieved. EEC decoding information collecting in single design iteration cycle cannot be improved, because supported codes with descriptions need to be searched from written manuals. Moreover, version management can be achieved for free, because EDS files include mandatory device version information. If same information were managed e.g. in spreadsheet, versions and languages still need to be managed manually. With e.g. spreadsheets, standardized links from device manufacturers to system integration and from system integration to software development are missing.

In the example project consisting of four types of devices with eleven codes in average, collection work from written manuals took approximately three work hours. Only English descriptions were included in manuals and Finnish descriptions were translated. After including the codes in an EDS file, they are usable in all projects using the same component. Execu-

tion time of the experimental collection routine is approximately 1 to 5 seconds, depending on the size and complexity of the project and the number of output languages. Execution can be linked as an integral part of the make process. Abstractions for EMCY producers are included as part of local interface export [6] [7]. The most significant result is that inconsistencies in EECs between producers and consumers were totally avoided despite of several revision cycles in each project.

Future work will concentrate on system-wide combining of EECs to support also remote EMCY decoding. It is already prepared by naming conventions. Also network number in parentheses at the end of comment line of the export supports future merging of the decoding functions. Other future area of interest is an option for producing multilingual decoding function. Final integration into current export tool may be performed after solving the system level collection. When EECs are included into EDS files, CANopen system design tools can improve troubleshooting by generating communication databases (DBC) with EEC decoding for CAN analyzer programs. ◀

# SYS TEC ELECTRONIC

## PRODUCTS

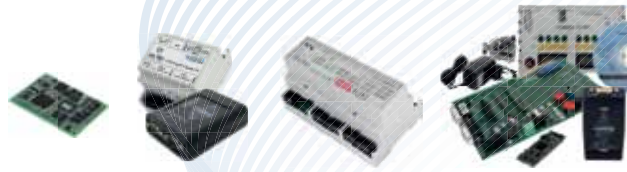

- System on Modules
- CANopen Protocol Stacks
- CAN Interfaces
- Automation Components

ETHERNET POWERLINK

CANopen

IEC 61131

## & CUSTOMIZED PRODUCT DESIGN

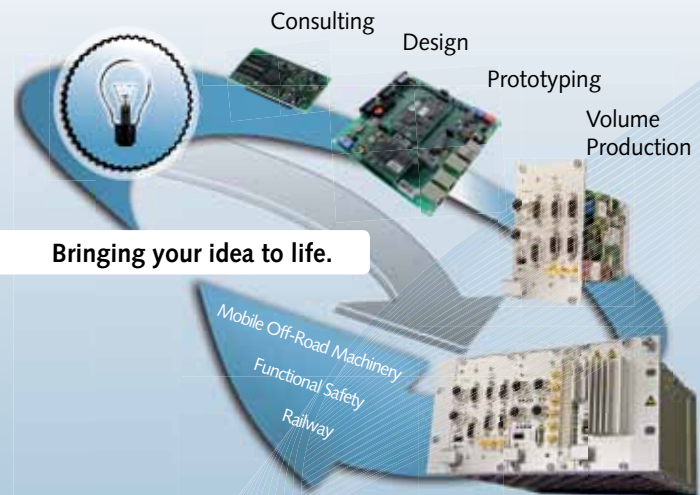

Bringing your idea to life.

Services that cover the complete product design process

- Consulting and Training
- Project Specification
- Hardware and Software Development
- Assembly and Volume Production
- Prototyping
- OEM Integration Services

**embedded world**  
Exhibition & Conference  
... it's a smarter world  
Meet us at Hall 4 / Booth 513

www.systemec-electronic.com  
phone: +49 3661 6279-0 | info@systemec-electronic.com

# CAN data transmission via a radio link

**Company**  
Schildknecht AG  
Haugweg 26  
DE-71711 Murr  
Tel.: +49-7144-89718-0  
Fax: +49-7144-89718-29  
office@schildknecht.ag

**Link**  
www.schildknecht.ag

The Dataeagle 6000 by Schildknecht (Germany) is a device, which may substitute the cables in CAN networks. It is able to transfer CAN messages on the data link layer (ISO/OSI layer 2) in a bidirectional manner. Therefore, the data transmission does not depend on the used higher-layer protocol. The CAN messages are received, checked and acknowledged by the device. Then, these are forwarded to one (point-to-point) or several (multiple-point) receiving devices via a radio link. To relieve the radio link, a whitelist containing the CAN-IDs of the transmitted messages may be created. A direct modulation of the CAN signals via the radio link is not possible. The device supports bit-rates of 10 kbit/s, 20 kbit/s, 50 kbit/s, 125 kbit/s, 250 kbit/s, and 500 kbit/s. Transmission of the 11-bit and 29-bit CAN-IDs (identifiers) is possible. The radio unit comprises the technique for transmission via short distances e.g. via

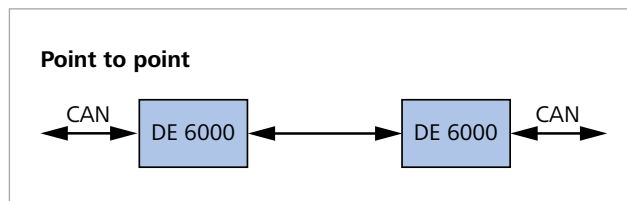

Figure 3: Point-to-point connection

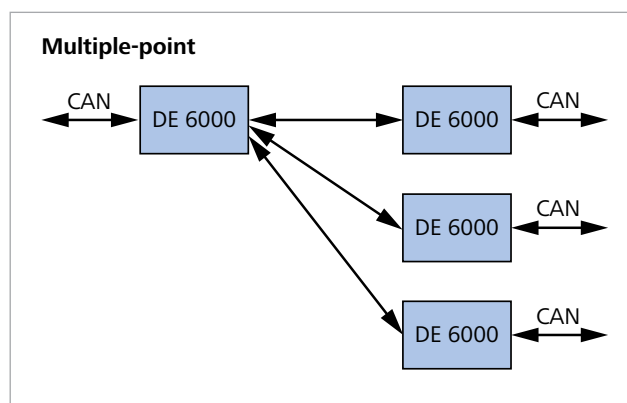

Figure 4: Multiple-point connection

Bluetooth (up to 500 m) and long distances via an 869-MHz (up to 3 km) link. The latency time (caused by radio transmission) of a Dataeagle device delays the signal transmission by ca. 2 ms.

The CAN-connectible Dataeagle 2000 version is

also available from the company. This does not transmit the messages in a 1:1 manner but extracts the data content of a CAN message and sends it to the another Dataeagle 2000 device (receiving partner). The receiving partner may also provide another network in- ▶



Figure 1: DE 6000 used with a CAN module by Helmholz on a S7 PLC



Figure 2: DE 6000 with a controller of Bernecker + Rainer coupled to a S7 PLC



interfaces such as Profibus DP, Profinet, and Modbus. Thus, the unit works as a protocol converter via a radio transmission. For example, by means of the unit, information from a Profinet-capable S7 PLC (programmable logic controller) by Siemens (Germany) may be transferred to a CAN-capable PLC by Bernecker + Rainer (Austria) via a wireless link. Different radio transmission technologies are possible. The linking is independent of the transmission technology. The common memory area is transmitted. The compact version of the unit (DE 2000 compact) provides 18 digital

I/Os, six analog inputs (0 V to 10 V) and six analog outputs (0 V to 10 V).

### Lifting device for heavy loads

The CAN-connected Dataeagle 6000 (DE 6000) was used in a heavy-load lifting facility from the German lifting system manufacturer Krah. The incorporated electronics was developed by E.R.S (Germany). The facility is able to lift, position and move loads weighting several tons. Therefore, four independent legs (each equipped with a PLC) are controlled and synchronized via a wire-



Figure 7: Electric control cabinet for a leg of the lifting facility



Figure 5: Lifting device for heavy loads



Figure 6: Lifting facility applied in Russia

less link. The PLC is from Bernecker + Rainer. It uses CAN for internal communication and the DE 6000 for the radio transmission. The latter transparently transmits data via a 2,4-GHz Bluetooth connection every 20 ms from a master leg to the three slave legs. Thereby, the current leg positions are permanently exchanged and supervised. This shall be done to avoid the shifting of the load. Former, without this safety function, severe accidents and damages to persons were happened. Since several years, the Bluetooth transmission has proven to be non-sensitive to disturbances if compared with the WLAN, Zigbee, Nanonet or DECT wireless technologies. Figure 6 shows a lifting facility used in Russia. The system heaves and moves tones of loads. Such systems are applied for raising the tall loads, because no crane may be used in these cases. For raising tasks two legs and for transportation tasks four legs of the system are used and synchronized.

to-machine) applications. Beside the data transmission it enables data storing in the cloud and also message transmission to the smartphones via Twitter. For the latter function the appropriate input of the PLC has to be activated.

Olga Fischer

### For M2M applications

The Dataeagle 7000, which can also be delivered with a CAN interface, was designed for M2M (machine-

# CAN-based distributed control of a breakstone cleaner

Krzysztof Szczeciak

## Author

Krzysztof Szczeciak  
Bosch Rexroth SP z.o.o.  
ul. Jutrzenki 102-104  
PL-02-230 Warszawa  
Tel.: +48-22-73818-47  
Fax: +48-22-75887-35  
krzysztof.szczeciak@boschrexroth.pl

## Link

[www.boschrexroth.pl](http://www.boschrexroth.pl)



The OT-84 breakstone cleaner with the train set

## Company background

Bosch Rexroth, a part of the Bosch Group, is a specialist in the field of drive and control technologies and is a partner for mobile applications, machinery applications and engineering, factory automation and renewable energies. It develops, produces, and sells components and systems in over 80 countries.

Consistently growing demand for transportation services and increasing requirements to travel speed and comfort entail the need to improve quality of railway tracks. To meet these demands it is necessary to design machinery that is able to perform their tasks with the top efficiency with consideration to enhanced quality standards. The example of such a machine

is the OT84 breakstone cleaner designed and constructed by ZPS from Starogard Szczeciński (Poland) in collaboration with Bosch Rexroth (Poland).

The breakstone cleaner is a vehicle (railroad machine) that is provided with hydraulic drives and dedicated to perform operations including picking up, cleaning and initial spreading of the breakstone located be-

neath the machine. The surveying facilities make it possible to lay the track subgrade with required slopes.

The machine subassemblies enable to carry out the full operation cycle: the hoist lifts the track and the chain drags the breakstone out from beneath. Upon having the breakstone cleaned it is transferred and spread on the track subgrade by means of dedicated conveyers. The machine is also provided with a traction drive. When the machine is running the lifting and shifting mechanisms raise the entire track up together with sleepers. Next the chain is attached and the moving chain pulls breakstone away from below the track and transfers it to the cleaning screen. After cleaning the dedicated conveyers transfer already treated breakstone back to the space below the track, whilst contaminations are disposed to dedicated cars pulled behind the machine. ▷

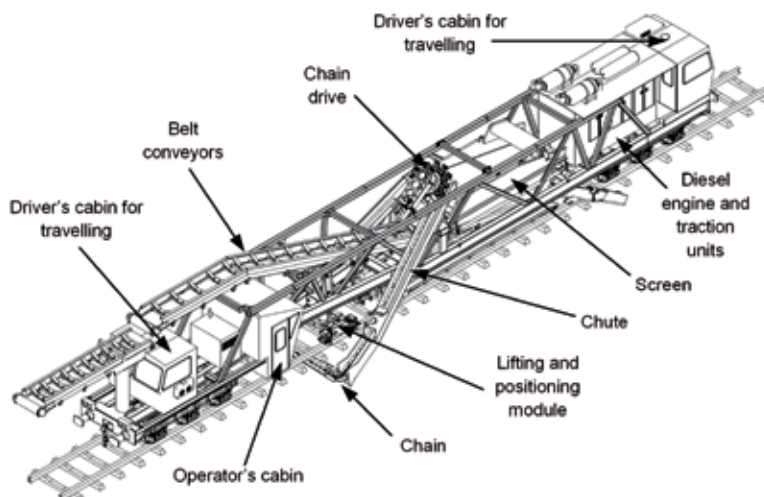

Figure 1: The OT84 breakstone cleaner scheme (Source: ZPS Sp. z o.o.)





*CAN in Automation*

We offer CAN and CANopen training for development engineers and system integrators. Topics include application fields, physical layer, protocol, communication services, standardization, and certification.

### **CAN/CAN FD training**

2013-05-14 Nuremberg (DE)

2013-12-10 Nuremberg (DE)

### **CANopen training**

2013-04-16 Copenhagen (DK)

2013-05-15 Nuremberg (DE)

2013-06-05 Parma (IT)

2013-07-11 Nuremberg (DE)

2013-10-10 Nuremberg (DE)

2013-10-22 Berlin (DE)

2013-10-23 Vaasa (FI)

2013-11-06 Nuremberg (DE)

2013-11-13 Utrecht (NL)

2013-12-03 Gothenburg (SE)

2013-12-11 Nuremberg (DE)

### **Special CANopen training**

2013-03-12 Safety Nuremberg (DE)

2013-03-13 Subsea Nuremberg (DE)

2013-03-13 Special purpose cars  
Nuremberg (DE)

### **Information days**

2013-12-04 CAN FD TechDay  
Frankfurt (DE)

2013-12-10 CAN and CANopen  
Trends and markets  
Nuremberg (DE)

### **In-house seminars**

CiA offers in-house seminars for companies with specific training requirements. The agenda of an in-house seminar is tailored to the customer's needs.

2013-10-01 Safety Nuremberg (DE)

2013-11-12 Special purpose cars  
Nuremberg (DE)

2013-12-04 Subsea Oslo (NO)

*For more details please contact the CiA office at  
[events@can-cia.org](mailto:events@can-cia.org)*

*[www.can-cia.org](http://www.can-cia.org)*



## The OT84 breakstone cleaner in figures

- Machine length: 27 m
- Machine weight: 105 t
- Power: 900 HP
- Maximum speed: 80 km/h
- Number of handled inputs: 243 of that 36 proportional inputs
- Number of handled outputs: 111 of that 51 proportional outputs
- Number of controllers: 5
- Number of hydraulic pilot valves with CAN interface (EPM2): 39
- Number of independent CAN paths: 7
- Number of displays: 5
- Number of CAN I/O modules: 5
- Number of inclinometers with the CAN ports: 5
- Number of measurement lines with CAN interfaces: 4
- Modules of RF remote control: 2 (few dozens of binary inputs per each)



Figure 2: Applied DI3 display



Figure 3: The 36-20/30 master controller



Figure 4: Pilot valve with CAN interface



Figure 5: Joysticks with CAN ports

### The control system

To enable smooth and reliable execution of these operations the machine is provided with the Bodas distributed control system. Each of aforementioned sub-assemblies has its separated controller that handles associated components of the control system (sensors, actuators, output signals and solenoid hydraulic valves). The machine comprises four controllers of the RC8-8/22 type (for traction units, conveyers, chain and screen) as well as the RC36-20/30 controller. All controllers communicate with each other via the CAN network and exchange the most important data, including values of process and control variables as well as information about disturbances. The RC36-20/30 controller acts as the network master unit to monitor and supervise operation of other slave controllers. It is also responsible for the tasks related to handling communication interfaces (displays, joysticks, actuators, output signals and RF controllers). In addition, it controls auxiliary hydraulic functions, such as air conditioning, lighting and others. Nevertheless the control system acts as the whole integrity of five controllers, each individual unit has been designed to perform its functions independently as an autonomous device,

even if installed on another machine.

The control system supervises and manages operation of the entire machine and helps the operator out in performing many jobs. Its advanced feature is automated control of the chain slope and depth to achieve proper embankment shape (see Figure 7). Owing to automation of the basic tasks the operator is capable to focus his attention on the process of the

breakstone collection and final spreading. Operation of the belt conveyors and the screen as well as traveling of the machine is partly automated. The conveyors and the screen start automatically with speed control. Also the slope angle of the screen can be positioned to achieve the most efficient operation of that unit. The traveling speed during the machine operation is automatically adjusted to the chain resistance. ▶



Figure 6: Display in the operator's cabin (basic screen)



Figure 7: Display in the operator's cabin (screen for chain leveling)

At any moment the operator is capable, if needed, to switch the machine over to the manual mode of operation. The electronic control system enables to monitor operation of the driving and traveling systems as well as to react to disturbances and errors. All the foregoing features guarantee the most efficient working conditions as well as safe operation of the machine over a prolonged lifetime.

### CAN interconnection

Another crucial component within the control system is the CAN network that enables transmission of digital information between individual controllers as well as between controllers and peripheral devices. The breakstone cleaner incorporates as many as 69 devices with the CAN ports, including controllers, 58 I/O modules and five displays. Application of the CAN system was imposed by the need to fulfill requirements of the manufacturer with the aim to reduce cable interconnections between huge number of measuring devices and actuators. The control system based on the CAN architecture proved more compact in size and transparent in design. The next requirement was elimination of control reliability by elimination of interferences on long electric lines running down the machine.

The CAN network usage makes the system scalable as it can be enhanced with additional components such as sensors, actuators, recorders, communication modules, and GSM/GPS units. It also enables distributed control (field-bus controllers are located close to measuring instruments and controlled devices). In order to handle all the system devices, seven separate communication paths were set up and routed in such a way that even in case of a fault on a single line the machine is kept operable. ◀

### Conclusion

*Application of the control system from Bosch Rexroth substantially simplified and accelerated operation of the breakstone cleaner machine (with simultaneous prolongation of its lifetime). It also improved safety of the machine operation and saved space that is occupied by drives and control units.*

# QNX and PREEMPT\_RT Linux

the stable and reliable real-time platform for embedded & distributed systems

**CAN | CANopen® | J1939**

## DACHS® Distributed Automation Control System

### Standard DACHS® products for CAN

- CAN Layer2, CANopen, and J1939 in real-time
- high performance drivers and APIs
- CANopen stack with sources
- IEC 61131-3 / IEC 61499 programming
- **DACHS**VIEW++ with C/C++ JIT Compiler

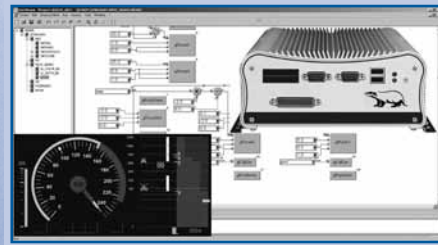

### supported boards:

PC/104, PC/104-Plus, PCI, PCIe, ISA, SoCs

### supported CAN controllers:

SJA 1000, i82527 or Bosch CC770, msCAN, HECC, TouCAN, etc. for x86, PPC, ARM9, etc.

OEM solutions and adaption for OEM platforms

CONSULTING & ENGINEERING



+49 (0)64 31-52 93 66 · info@steinhoff-automation.com  
www.steinhoff-automation.com · www.dachs.info

**FLEXIBLE | RELIABLE | INNOVATIVE | EMBEDDED  
PC-BASED | REAL-TIME | FIELDBUSES**

DACHS® Product Suite, support worldwide, consulting & engineering  
DACHS and the DACHS logo are registered trademarks of Steinhoff A.  
All other trademarks belong to their respected owners.

# Solar vehicle uses CAN for internal communication

Sébastien Walger

## Author



Sébastien Walger  
Renesas Electronics  
Europe  
Industrial Business Group  
Arcadiastr. 10  
DE-40472 Duesseldorf  
sebastien.walger@renesas.com

## Association contact

Jean-Luc Fleureau  
Eco Solar Breizh  
7 rue de Pouloupry  
FR-29200 Brest  
Tel.: +33-6-6300-8698  
information.ecosolar@gmail.com

## Links

www.renesas.eu  
www.ecosolarbreizh.com

## Introduction

Eco Solar Breizh association has taken a step forward to develop a solar car. The solar car will either extract the energy from the sun or from the kinetic energy of the vehicle.

CAN networking is used for car's internal communication reduces the wiring inside the vehicle.

Eco Solar Breizh association currently develops a car to participate in the World Solar Challenge, which consists of cruising in Australia from north to south with a vehicle driven by energy that must either come from the sun or must be recovered from the kinetic energy of the vehicle itself.

Difficulty for the association in this quest is to choose the appropriate semiconductor offer to manage energy in the racing car from solar panel energy and battery management to motor drive, calculations and communication. Renesas Electronics Europe is currently providing a wide range of solutions covering low-power and stand-by modes (e.g. the Snooze mode) on the low-end 16-bit RL78 micro-controller (MCU) up to the enhanced 32-bit RX device. The company offers a large number

of application notes, software examples, documentation and the information exchange by Renesas developers' community. This should ease the implementation of the MCUs for the developers.

There are several technical constraints for the development team. For example, the carbon structure of the chassis does not allow wireless communication. This is why the choice has been made to allow multiple back-up solutions for each task or system. To cite an example, the man-to-machine interface for the driver is possible via a smartphone with Android operating system spreading multiple information such as speed, battery level, etc. and enabling lights control. In parallel, direct command of lights via buttons has been taken in consideration during the main electronic calculator develop-

ment phase. In addition, the size and weights limits are important parameters to be taken under consideration. A heavier vehicle would have worse acceleration, braking, cornering and energy efficiency. The development was also focused on the limited available energy. For example, the on-board vehicle battery has a limited amount of energy, while the solar cells generate a limited amount of power. On top of that, the race environment is harsh. The vehicle has to withstand vibrations and high temperatures that limit the power, which can be used.

## CAN networking

Today, the development team is mainly focused on the electronic architecture, especially the implementation of the CAN network, which will permit to transmit crucial information to the



Figure 1: The solar vehicle



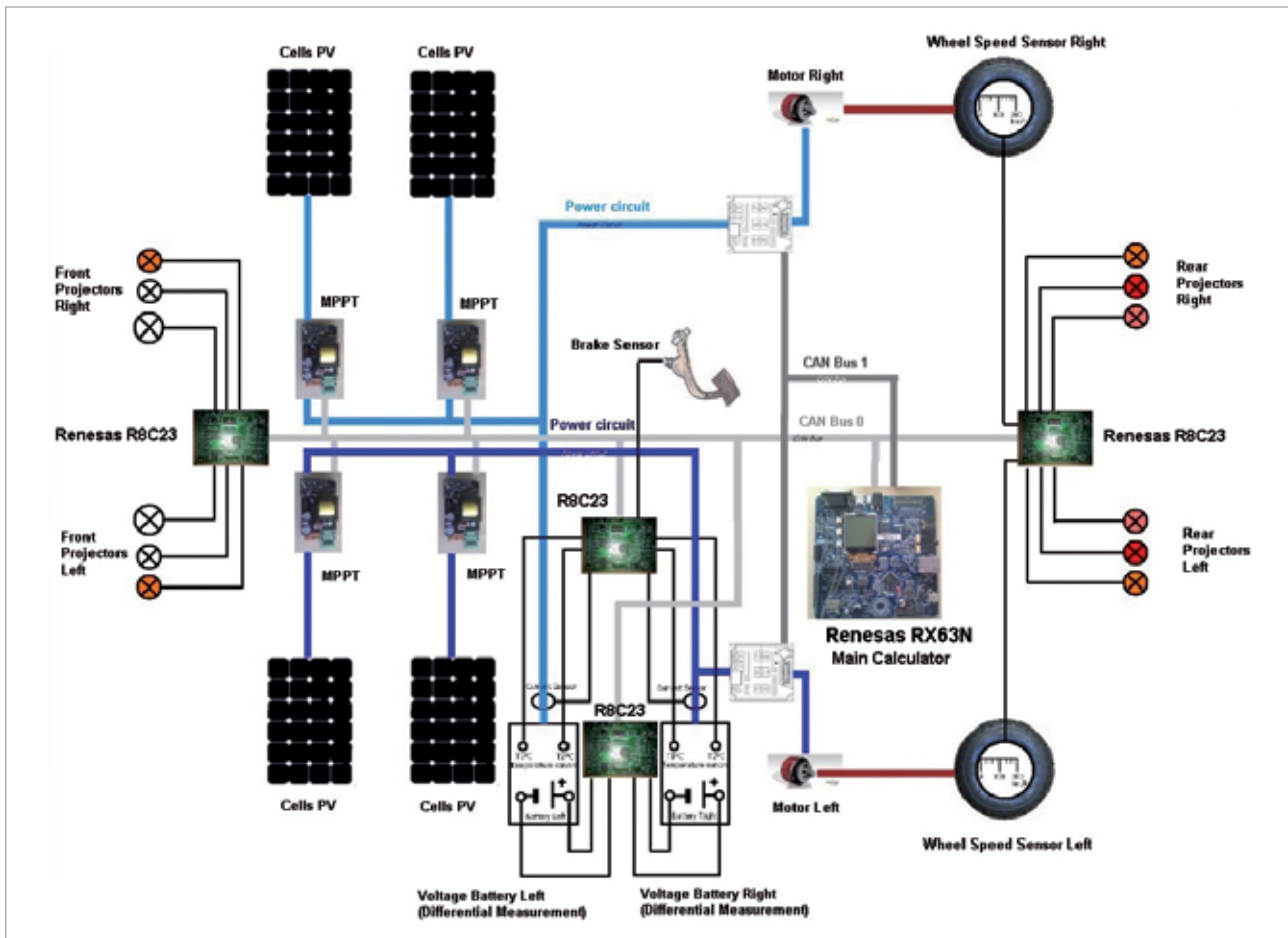

Figure 2: Solar vehicle block diagram

pilot. The use of CAN is explained by the fact of having a single communication network inside the vehicle. The advantages include a significant reduction of the wiring inside the vehicle, modularity and easy replacement of electronic boards. Usage of CAN also increases the security of the information that is exchanged using the

voltage-difference-based transmission. CAN network structure allows having flexibility in the car development. Interest in terms of image is not negligible either, since CAN is broadly used in the automotive domain and illustrates the idea that the solar vehicle could be a "real" car. Implementation of Renesas' devices into the

vehicle was done jointly with the local application engineers from the company.

### Data transmitted to the pilot

The main measurements transmitted on the CAN include e.g. currents and temperatures of the photovoltaic panels, vehicle

speed, engine load (electrical BLDC motor), current through the battery, and current in each motor. A lot of the information is received by the driver via CAN and is displayed on a touch pad. The communication between the main computer (Renesas RX) and the Android tablet is today fulfilled via Bluetooth. The development team is also working on a back-up solution to implement USB connectivity, which allows charging of tablet batteries.

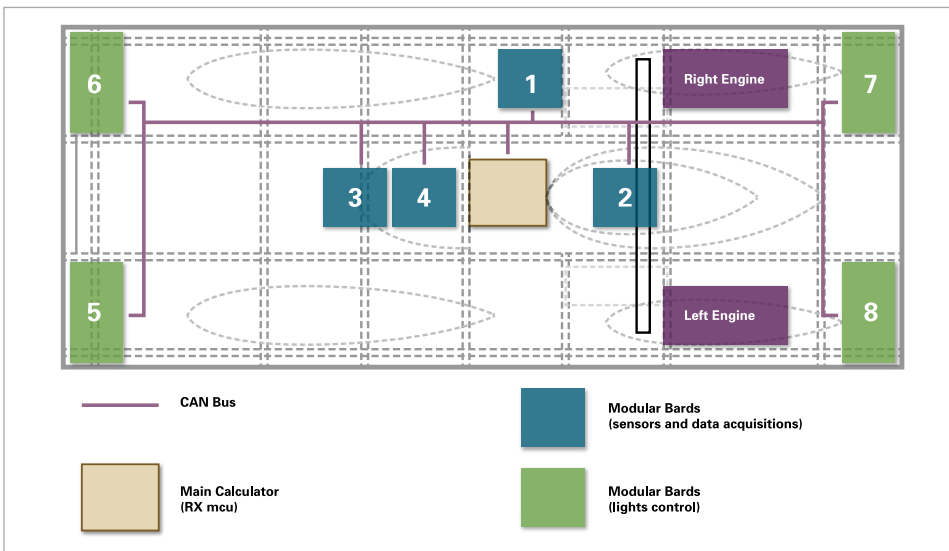

Figure 3: CAN network structure in the vehicle

### Modular electronic board

The R8C 16-bit micro-controller offers the functionalities needed to develop a modular and adaptive electronic board able to manage different actions. For example, it can measure temperatures (batteries and photovoltaic boards), get simple signals, control the solar vehicle lights, and man-

**Developer**

The aim of the Eco Solar Breizh association (France) is to compete in international solar-powered car races. The association is composed of private companies, academic institutions and volunteers. The first objective is to participate in the 2013 World Solar Challenge in Australia.

**Development status**

Today, the vehicle prototype is mechanically assembled in Brittany (France). The carbon structure is mainly finished. The solar panels are assembled and mounted. Specific batteries are currently under production. The motor control system is under benchmark testing, including mechanical aspects and electronic controller tuning. Innovation and research drive unified the development team. Since the beginning of the project in 2010, more than 75 students have participated in various developments, supervised by university graduates and industrial partners such as Renesas Electronics.

**Related articles**

B. Westhoff, CAN is easy to use!; in CAN Newsletter, September 2012

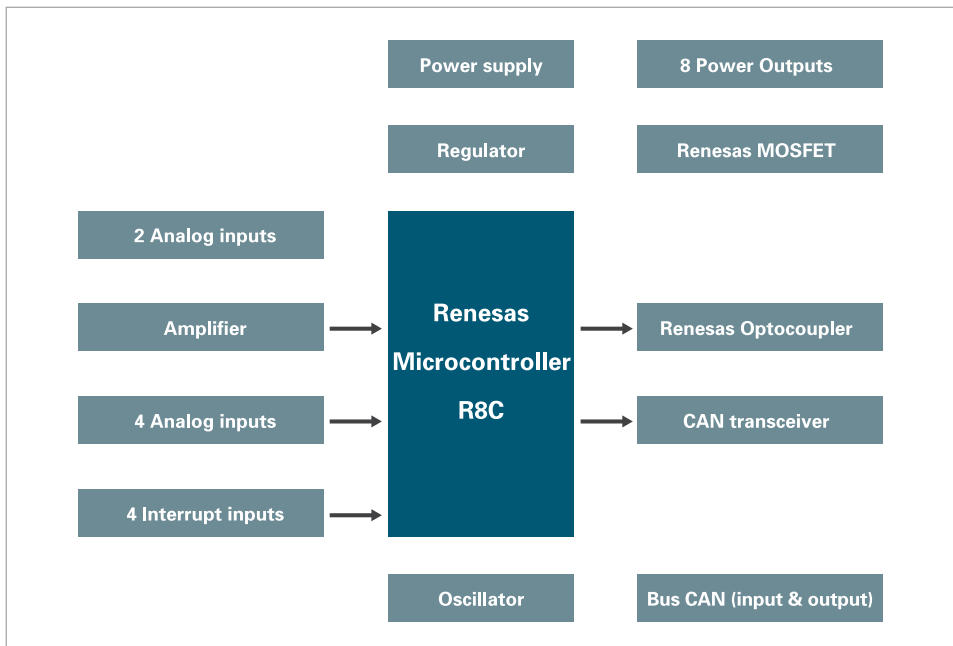

Figure 4: Modular electronic board architecture

age communication. These actions depend on where the team wants to setup this modular board into the solar vehicle. The device provides an on-board 10-bit A/D converter, data Flash, multiple timers and a CAN interface. The connected electronic boards are controlled by the main calculator (Renesas RX) via CAN. This functionality permits to reprogram the entire electronic system using the main calculator. To develop these electronic boards, Renesas also provided to the association such devices as micro-controllers, opto-couplers, and Mosfets.

**Main calculator**

As main calculator in the vehicle, the 32-bit RX micro-controller offers a good compromise between per-

formance and current consumption. The architecture delivers 1,65 DMIPS/MHz with FPU (floating point unit) and DSP (digital signal processing) features, which allow performing up to 165 MIPS with a 50-mA current consumption at highest CPU clock frequency. The micro-controller is designed for power-efficient

use allowing signals and data treatment or calculation. Main peripherals used in the developed system are CAN, UART, USB, timers and SD card interface. As described previously, the CAN is used for the communication between the main calculator and the different R8C modular boards, the DC/DC-Boost maximum



Figure 5: Vehicle conception includes such developments as motor control

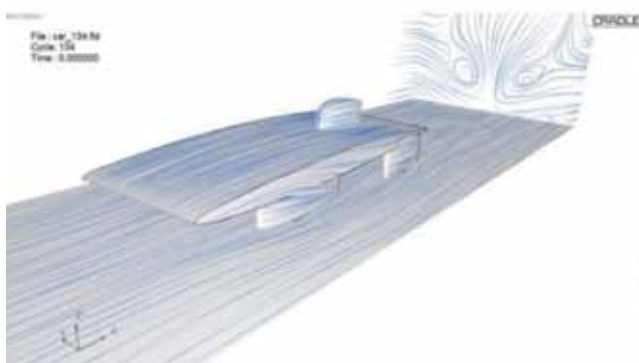

Figure 6: Vehicle modeling and simulation

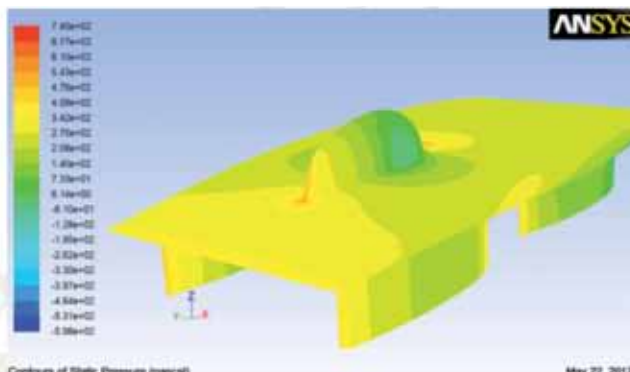



Figure 7: Several student groups are developing the project

power point tracker (MPPT) and the two electrical motor controllers. CAN messages received from each peripheral board can be displayed by the main controller on a terminal via the EIA-232 interface in case of vehicle debug tests. The timers are used to synchronize the sending of data to a smartphone via Bluetooth and also to trigger data recording into a data logger. The entire measurements are stored on an SD card, which allows analyzing recorded vehicle data after the tests and the race.

### MCU for energy harvesting

Regarding specific sensors and information management, constraints in current consumption oblige the team to employ the low-power RL78 micro-controller to be capable to develop autonomous systems using energy harvesting in the vehicle. On this subject, development is confidential and ongoing, but only possible with the RL78 using the Snooze mode, introduced by the chipmaker. With this feature, the MCU can be set up to accept a periodic A/D conversion or a serial port reception, while keeping the CPU in standby mode. This lowers the overall battery current drain. In case of energy harvesting, this capability allows to analyze or store measurements using vehicle's kinetic energy. In the suspension conception, the RL78G13

has been implemented to measure the values of constraint sensors, which measure physical forces applied on the structure. In this system conception, there is no battery and the only source of energy is the mechanical vibration of the suspension. The MCU current consumption (combining snooze and active modes) is low enough to create such an autonomous system. The measurements of the constraint sensors (with 10-bit resolution after A/D conversion) are triggered every second by the RTC without the need to wake up the CPU. Then, it compares the digitized value with the upper and lower limit pre-established in two writable registers. In this vehicle example, the configuration is made to wake-up the CPU only if the ADC result is outside of these limits. As a result, it achieves 10 % of the power consumption compared with using of standard topology in the Run mode. For example, in the Snooze mode the device consumes 0,5 mA versus 5 mA in the Run mode (using ADC). The MCU is able to run at 1,6 V to 5,5 V and to fulfill A/D conversion at 1,6 V. This allows the RL78-based subsystems to run on very low harvested voltages. An internal analog reference voltage (1,4 V) allowing getting measures independent from the supply voltage, is available as well. RL78 also includes a temperature sensor used by the development team to record ambient temperature values. ◀



## 14<sup>th</sup> international CAN Conference

Eurosites République, Paris (FR),  
November 12 - 13, 2013

### Call for papers

Please submit your abstract (not more than 200 words) before

**June 7, 2013.**

The conference language is English.

Suggested topics for the iCC:

- CAN FD
- CAN implementations
- CAN physical layers
- CAN tools and software
- CAN higher layer protocols
- CAN-related research studies
- CAN applications in vehicles
- CAN applications in industry
- CAN in general purpose applications
- Other CAN applications

For more details please contact the CiA office at  
[headquarters@can-cia.org](mailto:headquarters@can-cia.org)

[www.can-cia.org](http://www.can-cia.org)



# PLC controls CANopen drives via gateway

Dietmar Buxbaum

## Author



Dietmar Buxbaum  
Buxbaum  
Automation GmbH  
Thomas A. Edison Str. 1  
AT-7000 Eisenstadt  
Tel.: +43-2682-704-560  
Fax: +43-2682-  
2057700-5610  
office@myautomation.at

## Links

www.mymyautomation.at  
www.helmholz.de

## Introduction

Besides the other fieldbus systems, CAN is very popular among the manufacturers of frequency converters and servo controllers. The CANopen protocol with the available device profiles, such as the CiA 402 for drives and motion control, permits a flexible integration of drives for these tasks.

The CAN-enabled gateway modules of Systeme Helmholz allow to control the CANopen drives from the S7 PLC (programmable logic controller) by Siemens.

CAN was originally developed to reduce cable looms in vehicles. Once semiconductor manufacturers started developing interface modules and micro-controllers, the system soon became established outside automotive applications. Thanks to the flexibility of CAN, special higher-layer protocols have been developed for different applications. The CANopen protocol is the de facto standard in factory and process automation. The CANopen specifications developed and maintained by CAN in Automation (CiA) not only define the basic communication protocols but also a number of profiles for diverse devices and applications.

## Drive control

A typical application area for CANopen is drive control. The CiA 402 device profile for drives and motion control specifies the CANopen

communication interface for such devices. As the CANopen protocol uses CAN for the physical transmission, it allows not only master-slave communication architectures. It permits communication at the level of process data (PDO: process data objects), which are exchanged individually if required. The exchange of process data can either be triggered by a particular event (event-triggered), after a certain time (time-triggered), or by a global synchronization pulse (Sync triggered). This reduces overheads and response times on the CAN network. Synchronized process data exchange permits synchronous closed-loop control of several drives. Only those process data are implemented and exchanged that are required for the current application. If, for example, a drive is moved to a particular position, only the set-point and actual position as well as the command and

status information are exchanged with the PLC. In this operating mode other data is not necessary to be transferred.

Besides the process data communication used in cyclic operation, it is also possible to set individual parameters. The SDO (service data object) transmission is used for this purpose. All available parameters (called objects) of a CANopen device can be read or written by this transmission method. The full list of objects of a CANopen device, also called object dictionary, is usually listed in the manual of the device. The object dictionary can be accessed at any time, even in cyclic process operation. The CANopen specifications define the objects and their features required for diverse devices and applications. The CiA 402 CANopen profile defines parameters and closed-loop control sequences for such standard applications as e.g. positioning, speed control, homing, and torque control. The specification also offers extension possibility for special functions and vendor-specific additions.

## CAN products

The CAN product range of the automation specialist allows connection of CAN-based devices directly to the S7 controllers of Siemens. Besides the CAN 300 PRO module, the family includes a CAN 300 module designed for use in offshore applications with DNV (Det



Figure 1: Systeme Helmholz CAN product portfolio



Figure 2: CAN 300 PRO module

Norske Veritas) certification. Both modules have been designed for integration in the S7 mounting rail and operate in the ambient temperature range from -25 °C to +60 °C. A CAN interface for the S7-400 controller is available in two versions with one or two CAN ports. Beside the CANopen protocol, integration of devices according to J1939, DeviceNet, or manufacturer-specific CAN protocols is also possible with company's S7 CAN modules. Using the DP/CAN coupler, CAN devices are connectable to the Profibus applications. In addition, the manufacturer offers CAN connectors in various versions. ◀

### Implementation and support

*Buxbaum Automation is the Systeme Helmholz distributor in Austria. Systeme Helmholz provides application examples for the CAN modules including example projects and function blocks, which demonstrate how a CiA-402-compliant drive is controlled. The examples shipped with detailed instructions include positioning, speed control, and homing functionality. Further example functions are on development. The company also offers knowledge about the CAN, CANopen, and the CiA 402 profile. Commissioning support and generation of customer-specific programs for complex control tasks is also possible.*

### Summary

*CAN has become firmly established in the world of motors, drives, frequency converters, where it makes use of its advantages, and has by no means yet exhausted its possibilities. With its CAN-capable device portfolio, Systeme Helmholz offers a range of products for connecting automation devices to the Controller Area Network. Their capabilities may be extended further by additional functions and customer-specific features.*



## 1<sup>st</sup> international MMC conference

Nuremberg (DE), June 12 - 13, 2013

## Call for papers

Please submit your abstract (not more than 200 words) before

**March 20, 2013.**

The conference language is English.

Suggested topics for the MMC:

- Electronic control systems for:
  - Construction machines
  - Mining machines
  - Agriculture machines
  - Forestry machines
  - Truck-mounted body applications (e.g. fork-lifts, straddle-carriers)
- Higher layer protocols and profiles for mobile machinery
- Development and diagnostic tools for mobile machinery
- Safety-related controlling and networking for mobile machinery
- Security of electronic control in mobile machinery

For more details please contact the CiA office at [headquarters@can-cia.org](mailto:headquarters@can-cia.org)

[www.can-cia.org](http://www.can-cia.org)

# Subscription

Please use the following classifications for filling in your subscription form:

**A Position in company**

- 0. Other position
- 1. Director
- 2. Technical manager
- 3. Marketing manager
- 4. Sales manager
- 5. System designer
- 6. Device designer
- 7. Purchasing manager

**B. Company's CAN business**

- 0. Other business
- 1. Semiconductor manufacturer
- 2. Device manufacturer
- 3. Software house
- 4. System integration
- 5. Service provider
- 6. End-user
- 7. Research

**C. CAN application interest**

- 1. Passenger cars
- 2. Heavy-duty vehicles
- 3. Rail vehicles
- 4. Maritime vehicles
- 5. Aircraft/Aerospace vehicles
- 6. Power generation systems
- 7. Factory automation systems
- 8. Process automation systems
- 9. Industrial machine control systems
- 10. Construction machine control systems
- 11. Embedded control systems
- 12. Building automation
- 13. Door control systems
- 14. Lift control systems
- 15. Medical devices and systems
- 16. Science and research systems

**D. Company size**

- 1. 1 - 9 employees
- 2. 10 - 49 employees
- 3. 50 - 99 employees
- 4. 100 - 999 employees
- 5. 1000 - 9999 employees
- 6. 10000 - 99999 employees
- 7. more than 100000 employees

## CAN Newsletter

I hereby subscribe to the free-of-charge CAN Newsletter for the next four editions (published in March, June, September, and December of every year).

Print version       PDF version

Company

Name

Address

City, ZIP

Phone (Country code - Area code - Number)

Fax (Country code - Area code - Number)

E-mail

URL

Position (see A)

Application (see C)

Business (see B)

Size (see D)

I like to receive CiA's Weekly Telegraph

Please send your subscription form to CAN in Automation (CiA) GmbH, Kontumazgarten 3, DE-90429 Nuremberg, Germany, or fax it to +49-911-928819-79 or e-mail it to [headquarters@can-cia.org](mailto:headquarters@can-cia.org). You may also subscribe online at [www.can-cia.org](http://www.can-cia.org).





## Solutions for open networks from one source

Open CAN-based protocols are the basis of networking in commercial vehicles, avionics and industrial control technology. Vector supports you in all development phases of these systems:

- > Systematic network design with CANoe, ProCANopen and CANeds
- > Successful implementation with source code for CANopen, J1939 and more
- > Efficient configuration, test and extensive analysis with ProCANopen, CANoe and CANalyzer

Multifaceted trainings and individual consulting complete our extensive offerings.

**Thanks to the close interlocking of the Vector tools and the competent support, you will increase the efficiency of your entire development process from design to testing.**

- ▶ **Further information, application notes and demos:**  
[www.vector.com/opennetworks](http://www.vector.com/opennetworks)

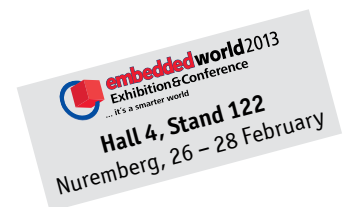

AFDX® is an Airbus' registered trademark

CAN-PCIe/400



PCI-104



CAN-PCI/400



Ethernet



CAN-USB/2



Gateways



# All you CAN plug

## CAN-PCIe/400

- PCI Express-CAN interface
- High performance CAN interfaces
- Local intelligence based on esd-ACC
- Data transfer rates up to 1 Mbit/s
- Electrically isolated
- Provides high resolution hardware timestamp

## CAN-PCI104/200

- PCI104-CAN interface
- One or two independent CAN interfaces for PCI104 bus
- Data transfer rates up to 1 Mbit/s
- Electrically isolated
- DeviceNet option available

## CAN-PCI/400

- High performance CAN interfaces
- Local intelligence based on esd-ACC
- Data transfer rates up to 1 Mbit/s
- Electrically isolated
- Provides high resolution hardware timestamps

## EtherCAN

- 10/100 BaseT Ethernet-CAN Gateway
- Ethernet protocols: TCP/IP, Modbus/TCP
- Data transfer rates up to 1 Mbit/s
- Configuration and Diagnostics by WEB Browser

## CAN-USB/2

- CAN-USB interface
- Intelligent CAN interface with ARM 7
- USB 2.0 high speed interface with data rates of 480 Mbit/s
- Data transfer rates up to 1 Mbit/s
- Electrically isolated
- Provides high resolution hardware timestamps

## CAN-CBX-I/O

- CANopen Input/Output Modules with In-Rail-Bus
- Connection of CAN and supply voltage without wiring effort
- Data transfer rates up to 1 Mbit/s
- Electrically isolated

## Gateways

- EtherCAT-CAN
- PROFINET-CAN
- PROFIBUS-CAN
- PROFIBUS-DeviceNet
- EtherNet/IP-CAN

## Operating Systems

esd supports the real-time multitasking operating systems VxWorks, QNX, RTX and others as well as Linux and Windows 32Bit/64Bit systems

## CAN Tools

- CANreal: Display and recording of CAN message frames
- CANplot: Display of online/offline CAN data
- CANrepro: Replay of pre-recorded CAN message frames via esd CAN interface
- CANscript: Python scripting tool to handle CAN messages
- COBview: Effective CANopen tool for the analysis/diagnostics of CANopen nodes

The tools are free of charge on the driver CD or can be downloaded at [www.esd.eu](http://www.esd.eu)

